

# RITCHEY User Manual

## Saddles and seat posts

Important information about use, care, maintenance and installation

### Contents

Introduction	1
Before Your First Ride –Determined Use	2
Special Characteristics of Carbon	2
Cleaning & Care	3
Maintenance	3
General Notes on Installation	3
RITCHEY Liquid Torque	4
Using a Torque Wrench	4
Installing the seat post	5
Installation of the RITCHEY “Mast Topper” seat post	5
Installing the saddle	6
Two bolt system	6
Single bolt system	6
Determining correct saddle height	7
Adjusting the seat post for correct saddle height	8
Installation of alloy seat post in steel,	
aluminium or titanium frames	8
Installation of carbon seat posts	8
Adjustment of the RITCHEY “Mast Topper” seat post	9
Fore-aft position and tilt of saddle	10
Adjusting saddle position and tilt	10
Installing a saddle bag	11
How to use seat clamp quick-releases	11
How to fasten the seat clamp securely	12
Warranty Terms	13
A Note on Wear	13
Manufacturer’s Guarantee	14

### Some Notes On This User Manual

Pay particular attention to the following symbols:

 This symbol means that your life or health may be in danger unless you comply with provided instructions or carry out prescribed measures.

 This symbol warns you about actions that could lead to damage of property or the environment.

 This symbol indicates there is special information on how to handle the product and may refer you to a specific passage in this manual requiring your special attention.

The possible consequences described above are not repeated every time one of the symbols appears!

## Introduction

Congratulations on your purchase of a RITCHEY component, you have made an excellent choice. At RITCHEY we develop, test and manufacture our products with dedication, and strive to uphold the highest standards of quality. Like all high quality sports equipment, RITCHEY components require careful installation in order to function properly and provide long-term dependability. We recommend that you seek the assistance of a qualified mechanic at your local authorized RITCHEY retail shop. We also recommend using all RITCHEY components to ensure optimal performance and durability. Our precise tolerances are intended to ensure component compatibility, and are carefully monitored during production and quality control so that installation will be easy and trouble-free.

This manual contains important notes about use, care, maintenance and installation.

Please read this manual in its entirety, beginning with the general information. Then you can carefully review individual chapters specific to each component you have purchased or intend to use. Doing so will help ensure smooth installation and trouble-free use of the product.

Retain this user manual for your records and future reference. If you sell or loan your component or bike, provide this manual to the new user.

With RITCHEY components, as is the case with all lightweight bicycle products, special care and attention are required for proper installation and use. Materials used by RITCHEY in the manufacture of its components are extremely strong and durable, yet low in weight, making them perfect for high-performance bike riding. It is important to note, however, that all materials, no matter how strong at the outset, are susceptible to wear, tear and fatigue over time, potentially becoming brittle due to extensive exposure to vibrations or impacts. In the event of a crash, significant impact, or undue stress of any kind, the component may not show obvious or visible signs of damage. However, since the material may have sustained undetectable external or internal damage, it is very dangerous to continue using a component after undue stress or a significant impact, because the component could eventually fail as a result, with unforeseeable consequences to your health or well being. After any such occurrence, consult your local RITCHEY dealer to get a professional examination and evaluation of the product.

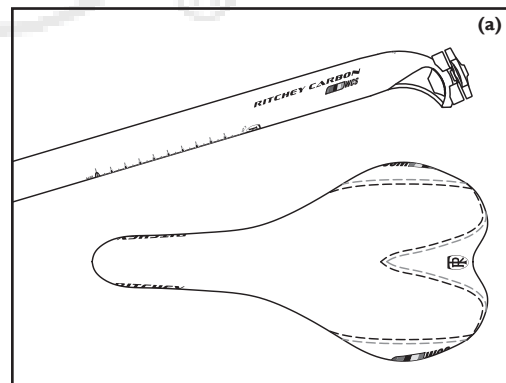

## Before Your First Ride – Determined Use

Most RITCHEY seat posts and saddles (a) are designed for use on road, triathlon (i.e. “time trial”), cyclocross or mountain bikes under normal riding and race conditions.

They are not built for freeriding, dual slalom, boarder cross / downhill, jumps and comparable use.

Never modify or change your seat post or saddle. Do not file or drill holes in RITCHEY components, especially those with carbon parts, as it will void your warranty and could compromise their structural integrity.

We strongly recommend using all RITCHEY parts in order to achieve optimal function and component durability. If you intend to combine RITCHEY parts with those from other manufacturers, ensure that all dimensions correspond exactly with those listed in this manual, and consult the other manufacturers’ user manuals regarding their specifications and restrictions!

The saddles and seat posts are designed to carry a maximum rider’s weight of 110 kilos (242 lbs)– luggage, eg backpack, included.

 If you have any questions or concerns, contact your local RITCHEY retailer.

 After a crash, accident or other major impact, replace the saddle and seat post for your own safety.

 If your seat post or saddle makes any “creaking,” “crackling” or “cracking” noises, or if there is visible damage, such as notches, tears, dents, discolorations, etc., do not use the bicycle until you have consulted your local RITCHEY dealer, who can check the part carefully and advise whether replacement is necessary.

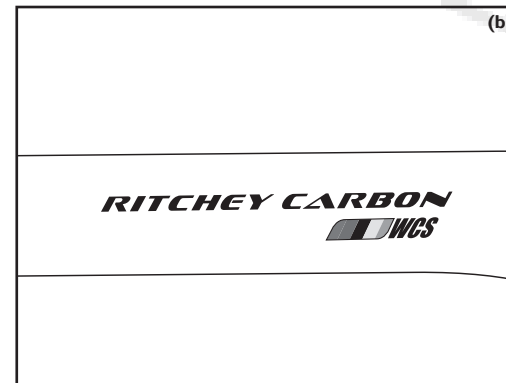

## Special Characteristics of Carbon

As is the case with all RITCHEY products made from carbon composites, (b) special care and attention is required.

Carbon is an extremely strong material which combines high resistance with low weight. Please note that carbon, unlike metals, may show no visible deformation after overstress even though sub-structures may be broken. This makes it very dangerous to continue using a carbon part after an impact or undue stress, because it can lead to an accident with serious and unforeseeable consequences.

If your RITCHEY carbon part has sustained this kind of impact or undue stress, we strongly recommend you take your complete bicycle to a local RITCHEY dealer for inspection, so you will know whether replacement is necessary. If there are any unanswered questions or doubts, the dealer can contact RITCHEY or one of our distributors directly.

RITCHEY components made of carbon must never be repaired; they must be discarded and replaced. Make absolutely sure that any damaged part is never re-used; it should be destroyed to ensure that re-use is impossible.

Parts made from carbon should never be subjected to excessive heat under any circumstances. Therefore, never paint a carbon component and attempt to cure it by heat. Temperatures required for the application of enamel or powder-coat paints will cause the carbon fibres to separate. Do not leave carbon components in a car left in the sun, or in direct sunlight for prolonged periods, and do not leave carbon components near sources of heat.

Components made of carbon have, like all lightweight bicycle parts, a limited service life. To be safe, RITCHEY recommends changing stems and handlebars, depending on usage, at intervals of three years, even if they were not involved in an accident or did not sustain a comparable impact.

Make sure all carbon clamping areas are absolutely free of grease and other lubricants. Grease will penetrate the surface of the carbon material, reducing the coefficient of friction and hence impairing the hold and undermining the stability of joined parts. Greased carbon may never again provide a safe clamping surface. If you install carbon parts, use RITCHEY Liquid Torque to achieve optimum friction where parts connect. This will allow you to tighten bolts to prescribed torque limits, execute proper installation and attain reliable, slip-free hold.

 If any dents, deformations, scratches, gouges or discolorations are visible on your carbon component, or if it makes “creaking” or “crackling” noises, do not use the bicycle until the part has been replaced! After undue stress, a crash or other major impact, replace the part or have it inspected by your local RITCHEY dealer before using.

## Cleaning and Care

Clean your seat post and saddle with water and a soft cloth. If necessary, use a non abrasive soap to remove grime. Only use gasoline based solvents for cleaning tough stains like oil or grease from hard surfaces. Do not use degreasing agents, which contain organic solvents (i.e. acetone, trichloroethylene, methylene, etc.). Chemicals of this sort may damage the finish or substructure of the material.

After drying your bike you can apply a wax based polish (a) to painted, carbon and metal surfaces. After the wax has dried, polish the parts. With this treatment your seat post will keep its nice finish for years.

### Saddles with a leather cover

Maintain leather surfaces by applying specialized creams or conditioning liquids every six months, or after each ride in rain, as well as in muddy or sandy conditions.

After the leather cream or liquid has soaked in, rub it in, then buff off any excess cream (b) to prevent the saddle surface from becoming slippery.

### Saddles with an artificial leather cover

Maintain the surface of artificial leather at least every six months or after rainy, muddy or sandy rides with a silicone-based liquid or spray.

After applying the silicone-based liquid or spray, rub it in, then buff off any excess spray to prevent the saddle surface from becoming slippery.



While cleaning, look for cracks, scratches, dents, as well as bent or discoloured material. If you think there may be a problem, see your local RITCHEY dealer. Have damaged or defective components replaced immediately.

## Maintenance

Check all bolts after the first 200-400 kilometres (120-240 miles) and adjust as needed, keeping within the prescribed torque limits. Check every 2,000 kilometres (1,200 miles) thereafter.

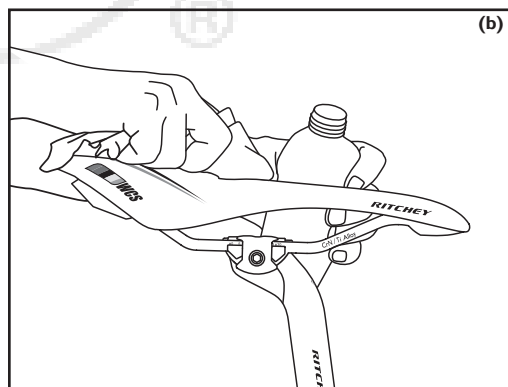
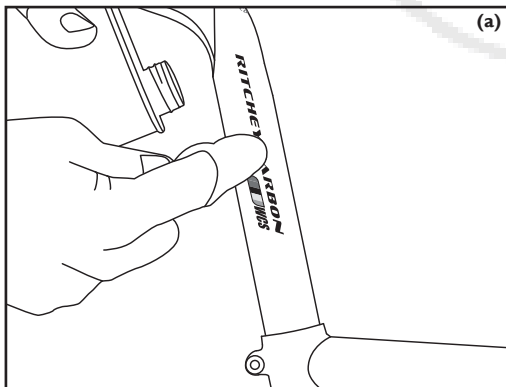

Once it is determined that a component is damaged, it should not be used under any circumstances. Stop using the bicycle until the part has been replaced! If there is any doubt, we recommend replacing the part.

We recommend using a RITCHEY seat post with a RITCHEY saddle and vice versa, because they are designed to fit and function as an integrated whole. If you choose to use a part from another manufacturer, consult their product documentation regarding clamp sizing to ensure proper fit and usability with a RITCHEY component.

RITCHEY assumes no responsibility for problems resulting from a RITCHEY component being used with a part from another manufacturer.

Watch out for burrs and sharp edges inside the bike frame's seat tube, on the frame's seat clamp and on the seat post's saddle clamp; do not install the seat post or saddle if you identify burrs or sharp edges. If there are burrs or sharp edges on your frame, or on a RITCHEY or a non-RITCHEY component, have your local RITCHEY dealer examine the problem in order to see whether the issue can be remedied and how.

Installation of parts with differing tolerances can cause problems due to incompatibility or poor fit, and can lead to component failure, as well as accident or injury.

Seat post installation and saddle installation are jobs for a qualified mechanic. For your own safety, have your local RITCHEY dealer perform the installation and maintenance jobs outlined in this manual. Each of the following instructions must be followed with exactness. Failure to observe these guidelines can cause a component to fail, resulting in a crash or injury.

## General Notes on Installation

## RITCHEY Liquid Torque

Installing components with RITCHEY Liquid Torque

Carbon fibre components are particularly vulnerable to damage caused by excessive clamping force. RITCHEY Liquid Torque (c) creates extra friction between two surfaces, allowing tightening torque to be reduced by up to 30%.

This is especially useful in clamping areas, such as between a handlebar and stem, or fork steerer tube and stem, or bar ends and handlebars – three areas where too much clamping force can damage either component, causing component failure or voiding the warranty. By reducing clamping force, RITCHEY Liquid Torque relieves stress on sensitive carbon surfaces, preventing damage to fibres or the cracking of the carbon sub-structure. It also retains its effectiveness in wet conditions and provides maximum protection against corrosion.

RITCHEY Liquid Torque can be used for all carbon, aluminium and steel connections, including:

- Seat post/frame interface area and seat post bolt threads
- Stem/handlebar interface area and stem bolts
- Stem/fork interface area and bolt threads
- Bolt threads in any area where reliable clamp force is required, but where loosening with the appropriate tool should be easy, even after prolonged use. RITCHEY Liquid Torque is ideally suited because it does not harden.

Directions for use: Prior to applying Liquid Torque, remove dirt particles and lubricant residues from the surfaces to be treated. Next, apply a thin and even coat of RITCHEY Liquid Torque to the cleaned surfaces using a brush, lint free textile or chamois/artificial chamois. Install components as directed by the manufacturer, using a torque wrench (such as the RITCHEY Torqkey, recommended for use with all RITCHEY handlebars and stems), taking care not to exceed the manufacturer's maximum torque recommendations. After tightening to specified torque, wipe off any excess Liquid Torque.

Re-seal RITCHEY Liquid Torque container after use.

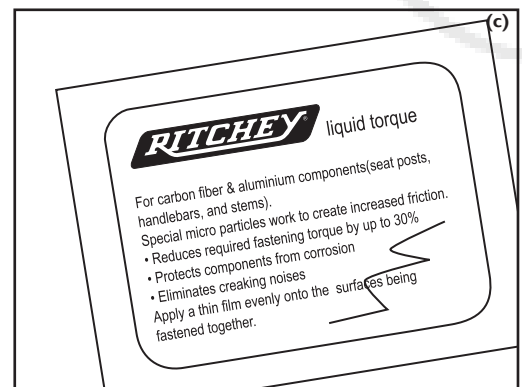

Additional information: Many manufacturer warranties will not cover damage to component due to over-tightening. Refer to manufacturer's recommended torque limits for each component. Always use a torque wrench to verify you are within specified torque limits, and do not exceed them. Using RITCHEY Liquid Torque will allow you to safely install your bicycle components – particularly in the case of carbon fibre – without exceeding the manufacturer's specified torque limits. In most cases, using Liquid Torque will enable you to use as much as 30% less torque while installing your components.



RITCHEY Liquid Torque is neutral to copper and aluminium alloys, steel and synthetic material, and will not damage product surfaces.

## Using a torque wrench

To achieve long lasting and problem free clamping of parts, RITCHEY considers the use of a torque wrench (d) absolutely necessary.

If the maximum torque given by RITCHEY does not generate sufficient clamping force, apply RITCHEY Liquid Torque to interconnecting surfaces to increase friction.

Exceeding recommended torque (generally indicated somewhere on the clamp assembly) on RITCHEY seat post bolts will create too much clamping force, running the risk of component failure and the voiding the warranty.



Loose or overly tightened bolts can lead to failure and therefore to an accident. Adhere to torque specifications carefully. If you do not have access to a high-quality torque wrench, see your local RITCHEY dealer.

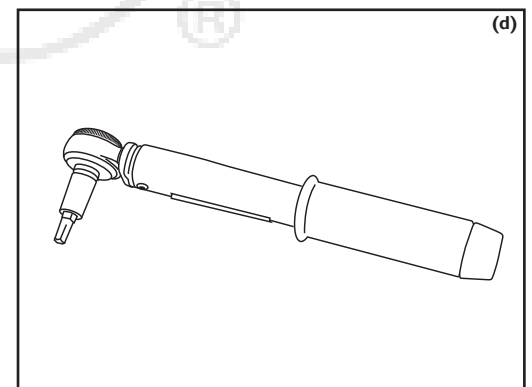

## Installing the seat post

Make sure the seat post matches the inside diameter of the seat tube of the frame.

Measure seat post (a) and seat tube (b) of the frame. The difference between the (bigger) inside diameter of the seat tube and the (smaller) outside diameter of the seat post should be between 0.05 and 0.1 mm.

Before the seat post is inserted into the seat tube, make sure that the seat tube is absolutely free of sharp edges or burrs (c). If you will be inserting a carbon model RITCHEY seat post, make sure the inside of the seat tube is totally degreased! A qualified mechanic can remove seat tube burrs and smooth as necessary.

If the diameter fits and there are not any burrs, insert the seat post slowly and carefully into the seat tube. Avoid inserting the seat post further than necessary so as to avoid marring the finish along what will be the visible portion of the seat post shaft.

The seat post must fit snugly into the frame, without the need to push or twist.

Conversely, the seat post should not have play and should not tilt inside the seat tube.



Incorrect mating of the seat post and seat tube can cause seat post failure, resulting in a crash and potential injury to the rider.



Tighten the binder bolt or quick-release mechanism of the seat post clamp (read the section below, "How to use quick-releases"), so that the seat post does not slip when you install saddle as described further on.

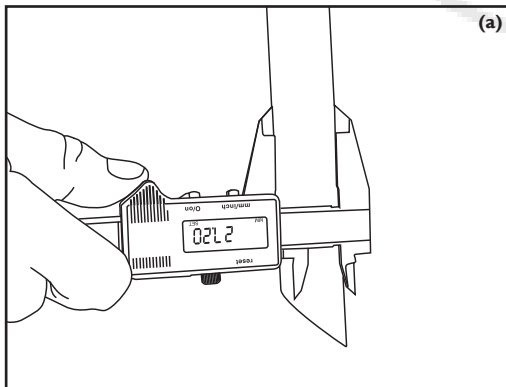

(a)

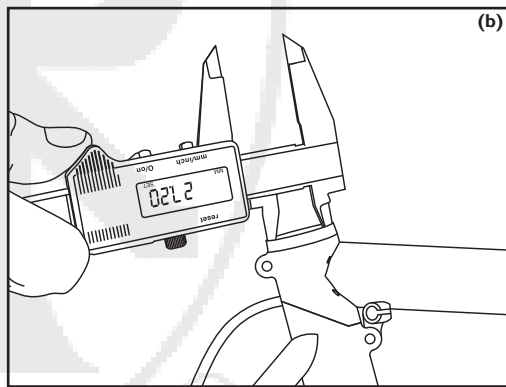

(b)

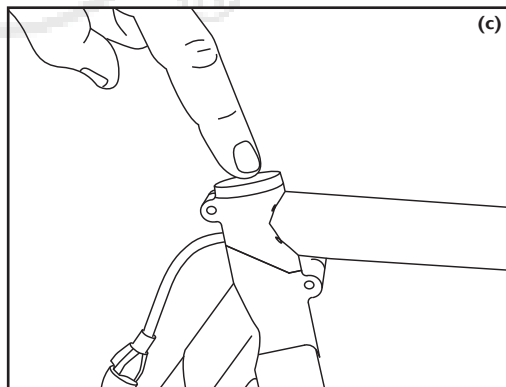

(c)



Strictly follow the frame manufacturer's directions, and seek the assistance of a certified and qualified mechanic. RITCHEY cannot accept responsibility for seat tubes that are cut to incorrect length or that are damaged by incorrect installation of its mast topper seat post.

## Installation of the RITCHEY "Mast Topper" seat post

Installation of a mast topper seat post (p. 9) has a lot in common with normal seat post mounting, except that it is mounted on the exterior (as opposed to the interior) of the extended seat tube of certain frame models. In other words, the extended seat tube is inserted in the mast topper seat post. All of the information listed in this manual about tolerances in diameter and the absence of lubricants for carbon parts are the same.

In order to install a RITCHEY mast topper seat post, this kind of frame design generally requires that the seat tube be shortened in order to achieve appropriate saddle height. This operation should only be performed by a certified and qualified mechanic.

In order to install a RITCHEY mast topper seat post, this kind of frame design generally requires that the seat tube be shortened in order to achieve appropriate saddle height. This operation should only be performed by a certified and qualified mechanic.

## Installing the saddle

### Two bolt system

The RITCHEY two bolt seat post is designed to suit most performance bicycle saddles with round 7 mm diameter rails – including all RITCHEY saddles – as well as with ovalized rails within 7 mm width x 9 mm height dimensions. To install the saddle, unscrew both fixing bolts 4 to 5 turns. It is often not necessary to take the mechanism completely apart. If the width of the saddle rails does not fit exactly into the clamp grooves, do not try to force them in! This can cause the clamping mechanism or the saddle rails to break, resulting in a crash and potential injury to the rider. Use a different saddle model or consult your RITCHEY dealer for help.

If the saddle rails fit into the seat post clamp grooves, slide the saddle so that the clamp is positioned midway along the rails' total length (d). Then position the saddle so that its upper surface is parallel to the ground. Turn the bolts alternately in small increments so that the seat post clamp gradually and evenly tightens around each rail.

Once there is uniform hold on both rails, tighten the bolts alternately and gradually with a torque wrench (e) until each reaches maximum specified torque, listed on the seat post in newton-meters (Nm).

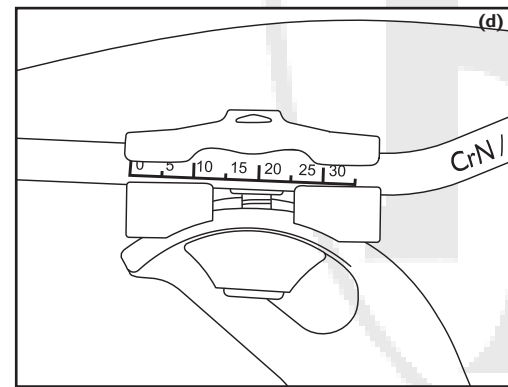

(d)

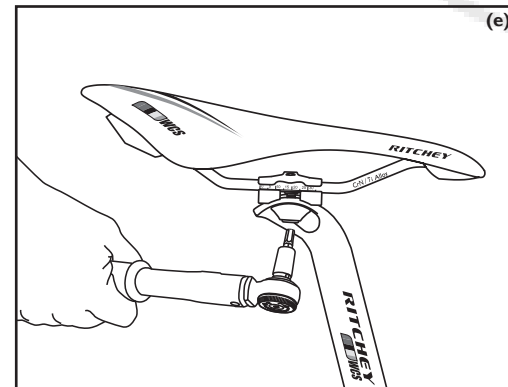

(e)

### Single bolt system

The RITCHEY single bolt seat post standard clamp is designed to interface with most performance bicycle saddles featuring round 7 mm diameter rails, including all RITCHEY saddles. Replacement outer clamps are also available to accommodate ovalized rails of 8 mm height x 8.5 mm width, as well as carbon saddle rails beyond the 8 x 8.5 mm dimensions. Contact your RITCHEY dealer if you are uncertain what type of rails your saddle has or if you require more information.

To install the saddle, unscrew (f) the fixing bolt as far as possible without loosening from the lock nut on the other side of the clamp assembly. It is generally not necessary to take the mechanism completely apart if it is already equipped with the correct outer clamps for your saddle.

If you do find it necessary to unscrew the single fixing bolt completely, proceed to remove it from assembly. This will free up outer clamp pieces. Inner clamp pieces are held in position with rubber retention plate (leave in place). Install saddle rails into inner clamp pieces, add outer pieces and re-insert fixing bolt.

If the width of the saddle rails does not fit exactly into the clamp grooves, do not try to force them in! This can cause the clamping mechanism or the saddle rails to break, resulting in a crash and potential injury to the rider. Use a different model saddle or consult your RITCHEY dealer for help.

If the saddle rails fit into the seat post clamp grooves, slide the saddle so that the clamp is positioned midway along the rails' total length (g).

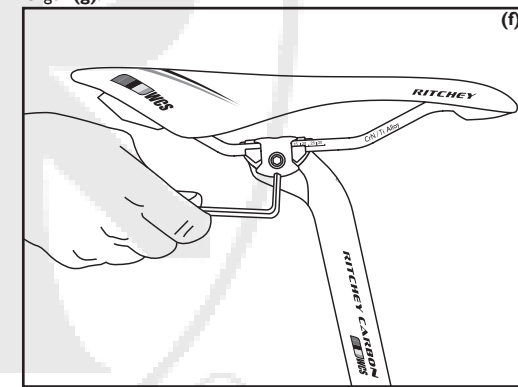

(f)

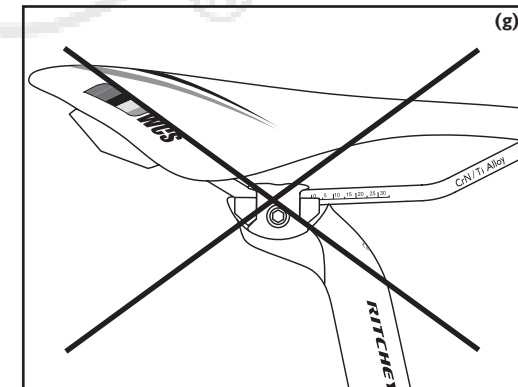

(g)

Then position the saddle so that its upper surface is parallel to the ground. Turn the bolt gradually and ensure that

- 1) the clamp assembly is still properly mounted on the carbon fiber seat post head and
- 2) that the clamp is tightening evenly around each rail.

Once there is uniform hold on both rails, tighten the bolt gradually with a torque wrench until you've reached specified maximum torque, which is listed on the seat post in newton-meters (Nm).

#### Both systems

 Check to ensure the saddle rails are being held securely in the seat post clamp by grabbing (a) the front and back of the saddle and weighting each end alternately to see whether it moves. A loose saddle can lead to an accident.

 If the clamping mechanism on the WCS carbon seat post can not be tightened in place by tightening the bolt(s) to the specified torque, do not ride the bike until you have resolved the issue with the help of your local RITCHEY dealer.

Never exceed RITCHEY's recommended torque, specified on the components.

If you have any doubt regarding proper torque, or you do not have a torque wrench, seek the assistance of a RITCHEY dealer. Failure to do so could lead to the over-tightening of bolts, causing premature wear or component failure while riding, which could in turn lead to a crash and potential injury.

## Determining correct saddle height

Correct saddle height provides maximum pedaling comfort and efficiency. When pedalling, the pedal axles (or "spindles") should be positioned directly below or slightly behind the ball of your foot.

With the pedal axles positioned under your feet as described above, your legs should not extend completely at the pedal's farthest point from the saddle during your pedal stroke, otherwise your motions will become awkward and you can stress your knees and other joints.

You can check the height of your saddle in the following, simple way. This is best done wearing flat-soled casual shoes.

Sit on the saddle with your hips even and put your heel on the pedal at the pedal's most distant rotational point from the saddle. In this position your leg should be fully stretched and your hips should not be tilted to either side (b).

 When riding off-road it can be helpful to lower the seat post slightly. However, be aware that a lower seat post position over extended periods can lead to knee pain. If you experience knee or hip discomfort, immediately seek the advice and assistance of a certified bicycle fit expert or qualified retailer.

## Adjusting the seat post for correct saddle height

To modify saddle height, loosen the seat clamp binder bolt or quick-release lever (first read the section below: "How to use quick releases"). Use a suitable tool to loosen the seat clamp binder bolt, turning it counter clockwise two to three turns, or open the seat clamp quick release.

Now you can adjust saddle height to the desired position.

Be sure not to pull the seat post too far out of the seat tube. The "hash" marks or numbered position lines on the back of the seat post will serve as a guide, especially the "Min. Insert (c)" (i.e. "Minimum Insertion") line.

 In the case of frames with seat tubes that extend beyond the top of the frame's top tube, the seat post should be inserted into the seat tube at least a few millimeters below the bottom of the top tube and below the top of the seat stays! This can mean a minimum insertion length of 10 centimeters (4.5 in.) or more.

## Installation of alloy seat posts in steel, aluminium or titanium frames

Make sure that the portion of the seat post inserted inside the seat tube is always well greased. Do not use brute force to insert the seat post or move it up and down inside the seat tube if it does not move easily. Instead, ask your RITCHEY dealer for assistance.

## Installation of carbon seat posts

If you use carbon seat posts you have to make sure that the seat tube – no matter what material it is made of – is absolutely free of lubricants. For road bikes, which do not generally require saddle height adjustments during a ride, apply RITCHEY Liquid Torque to the seat post shaft and the inside of the seat tube to ensure the best possible hold at specified clamp bolt torque. (d)

Tighten the seat clamp again by either turning the seat post binder bolt clockwise or by closing the quick-release (first read the section below: "How to use quick releases"). Closing the quick-release should not require much strength or force. If it does, it may indicate that the seat post is the wrong diameter for the frame's seat tube.

Verify that the seat clamp is sufficiently tight by taking hold of the saddle at both ends and trying to rotate the seat post inside the seat tube. This should not be possible to do. If the seat post does rotate, you may need to further tighten the clamp bolt or the quick-release in small increments and check again, making sure not to exceed the recommended maximum torque.

If there is still movement, verify that the bolt has been tightened to the recommended torque. If you are unsure what the proper torque is for the given seat clamp, check the manufacturer's user instructions, or seek the assistance of an authorized dealer. If the recommended torque has been applied to the bolts and the clamping force is still not sufficient to hold the seat post in place, loosen the bolt, remove the seat post from the seat tube, apply RITCHEY Liquid Torque to clamp area and tighten the bolt again to the specified torque. If the seat post is still not held firmly in place, seek the assistance of a RITCHEY dealer or other qualified mechanic.

 In the case of an alloy seat post, never apply grease or oil to a seat tube made of carbon, unless an aluminium sleeve has been inserted to interface with the seat post. If you install a carbon fibre seat post, do not apply grease to it or the inside of the seat tube, even if the seat tube is made of a steel or alloy. If carbon fibre parts have had contact with grease or oil, they may never be able to be clamped in a secure and safe way again.

 Take care not to over-tighten the clamping mechanism of the seat tube. Too strong a clamping force can cause the seat post and/or the frame to fail, which can lead to an accident and possible injury to the rider.

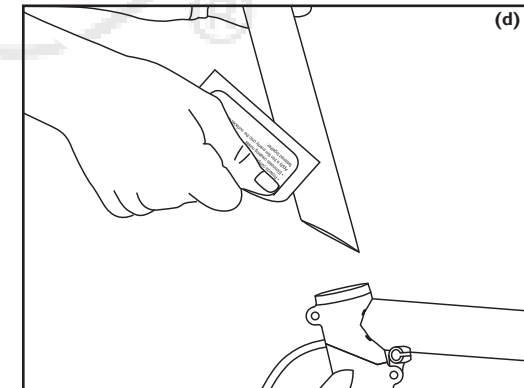
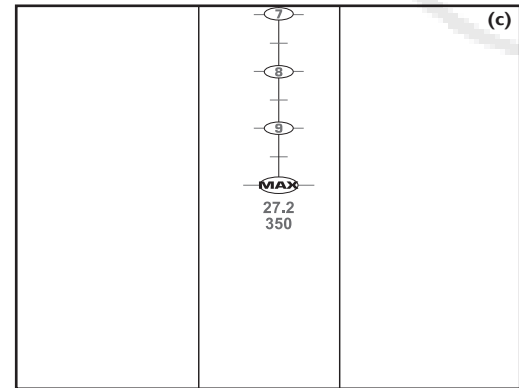
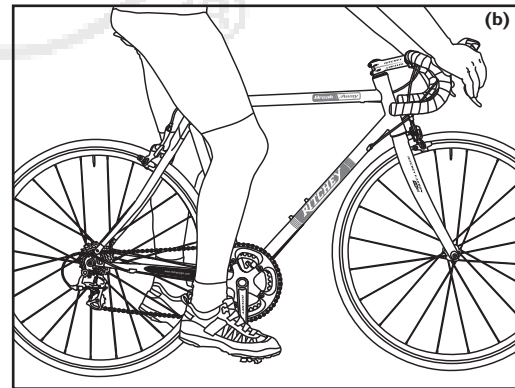
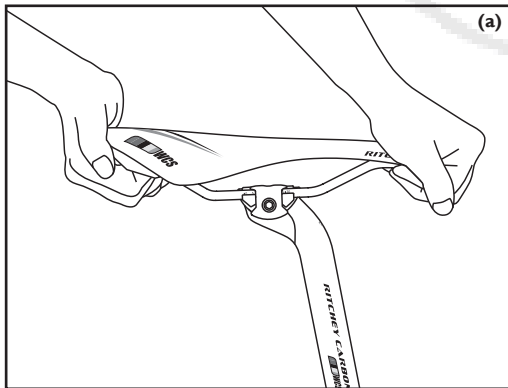





Has the leg extension test described above produced a desirable result? Check by moving the pedal to its farthest rotational point from the saddle and placing the ball of your foot over the pedal axle or slightly forward (the ideal positioning for efficient pedaling). If your knee is slightly bent, you have probably positioned the saddle at the correct height **(a)**.

Check whether you can balance safely on your bike while stopped by sitting on the saddle and extending your legs and touching your toes to the ground. If not, you should lower the saddle until you can, at least to begin with.

Never ride your bike with the seat post drawn out beyond the minimum insertion mark! The seat post might break or cause severe damage to the frame **(b)**. It could also result in a crash and potential injury.

 In the case of frames with seat tubes that extend beyond the top of the frame's top tube, the seat post should be inserted into the seat tube at least a few millimeters below the bottom of the top tube and below the top of the seat stays! This can mean a minimum insertion length of 10 centimeters (4.5 in.) or more.

 If sitting on your bike causes numbness in your crotch, it could be due to the saddle. Your local RITCHEY dealer should have access to a wide range of saddles and can assist you in finding and choosing one that is comfortable and does not cause numbness.

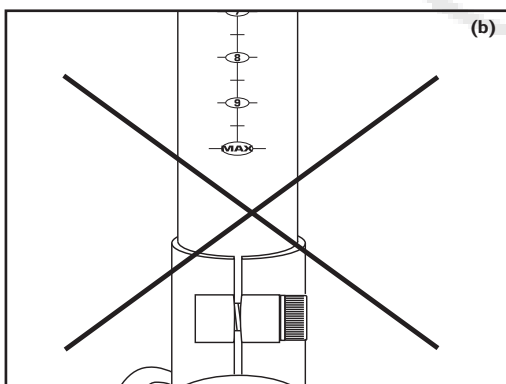
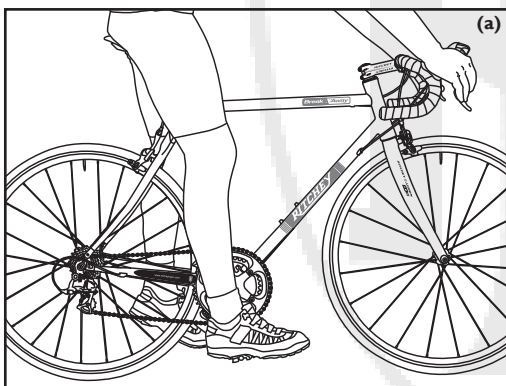

## Adjustment of the RITCHEY "Mast Topper" seat post

The range of vertical adjustment is approximately 20 mm, which is why the extended seat tube of a compatible frame must be carefully measured and cut to precisely the right length.

In order to fine-tune and finalize your saddle position, loosen the bolt one to two turns and shift the mast topper seat post up or down a few millimetres, as needed. If the uppermost end of the seat tube is visible in the slot of the mast topper seat post, the seat tube is not inserted far enough into the mast topper seat post and sufficient clamping hold might not be possible, potentially resulting in failure, which could lead to an accident and potential injury **(c)**.

If the uppermost end of the seat tube is not visible in the slot of the mast topper seat post, adjust the mast topper seat post clamp according to directions in the "Adjusting the seat post for correct saddle height" section. Also read "Installing components with RITCHEY Liquid Torque" and implement Liquid Torque as needed for sure clamping hold.

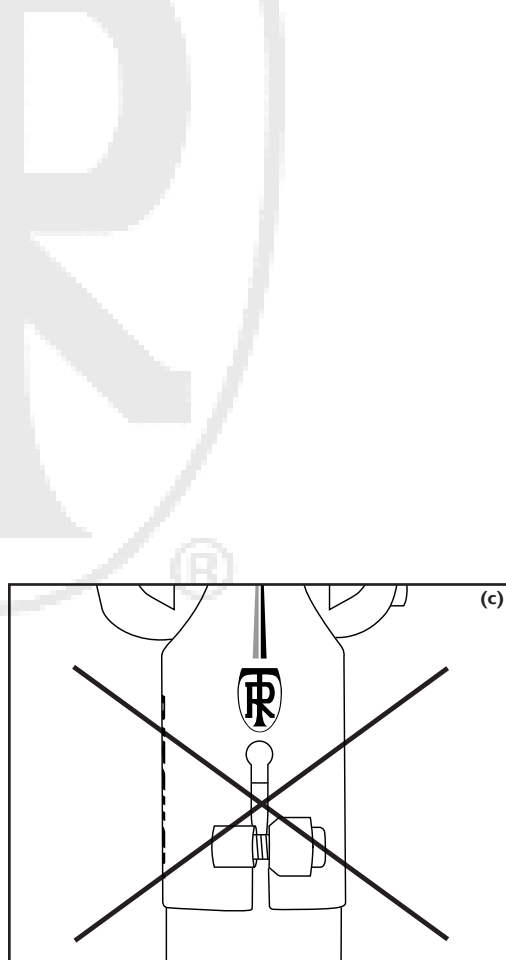

## Fore-aft position and tilt of saddle

The inclination of your upper body, and hence your riding comfort and pedalling power, are partially influenced by the distance between the handlebars and the saddle. This distance can be altered slightly by changing the position of the saddle rails in the seat post clamp.

Be aware, however, that this also influences your position relative to the cranks and may affect your pedalling motion.

Depending on whether the saddle is positioned more forward or more backward in the seat clamp, your legs will extend farther or not as far forward.

The top of your saddle must be close to horizontal **(d)** in order to pedal in a relaxed manner. If it is tilted forward, you will need to apply additional pressure on the handlebars to prevent yourself from slipping forward on the saddle.

When riding off-road, especially on a full-suspension bike, your position may vary. That means the nose of the saddle may point slightly upward or downward. For best results and to ensure your comfort and safety, seek assistance from a local RITCHEY dealer.

 A saddle's range of adjustment is very small. Replacing the stem allows you to make bigger changes to your position, because stems come in differing lengths at one centimeter intervals. Changing your stem may require changes in shifter and break cable lengths – a job best left to your RITCHEY dealer!

 Make sure the seat post clamp assembly is not positioned too close to the bends in the rails at either end of the rails' flat mounting section.

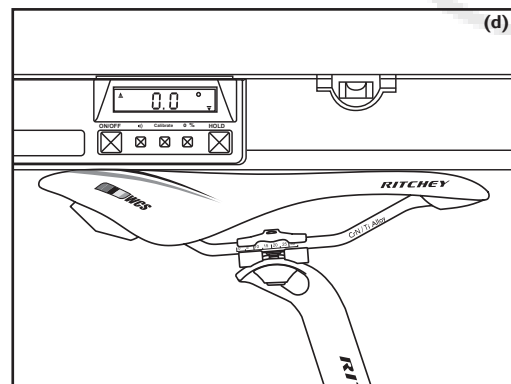

## Adjusting saddle position and tilt

RITCHEY seat post clamp designs consist of one or two bolt clamping assemblies used to adjust the horizontal orientation and tilt of the saddle.

Loosen seat clamp bolt(s) at the top of the seat post. Turn the bolt(s) counterclockwise no more than two to three turns to begin with, otherwise the whole assembly can come apart.

Move the saddle forward or backward by sliding its rails in the loosened seat post clamp. To adjust tilt, put one hand on the front of the saddle and one on the back and carefully rotate the saddle in either direction.

You may need to give the saddle a light tap initially to get it to move in the assembly.

Make sure the top surface of the saddle remains horizontal as you tighten the bolt(s). Ensuring that the bike is on level ground will make it easier to determine proper position.

Retighten the bolt(s) with a torque wrench according to the torque specified on the seat post's clamp assembly.

After tightening bolt(s) to proper torque, check to see whether the saddle can still be moved or tilted by putting one hand on the back of the saddle and one on the front, then alternately applying pressure, first to the front and then to the back. **(e)**

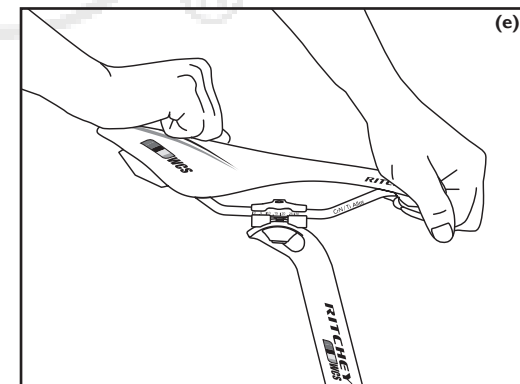

## Installing a saddle bag

While choosing and installing a saddle bag, be sure it fits securely to the saddle rails; some models also connect to the seat post. Once installed, a saddle bag should not swing when the bike is being ridden. A swinging bag can mar the finish of the saddle or seat post, as well as distract or disturb the rider, which could prove dangerous.

Ask your RITCHEY dealer for help in selecting a well fitting model.

## How to use seat clamp quick-releases

Because the proper use of quick-releases is not common knowledge, they have often been the cause of accidents. We strongly suggest you read the following instructions and practice the procedures as outlined.

Quick-release retention mechanisms essentially consist of two adjustable parts **(a)**:

1. A lever on one side of the clamp attached in a hinged fashion to the clamp's binder bolt. When the lever is opened, it loosens the clamp. When it is closed, it tightens, generating significant clamping force.

2. The binder nut on the other side of the clamp used to adjust and set tension by moving it one way or the other along the threaded portion of the binder bolt.

## How to fasten the seat clamp securely

Open the quick-release **(b)**. In many cases you will see "Open" marked on the lever.

Close it again. Now you should see "Close" marked on the outside of the lever.

When closing the lever, it should at first move easily, not yet tightening the clamp.

As you move the lever toward full closure, you should feel increasing resistance, until it takes considerable effort at the end. Use your thumb to push on the lever while your fingers wrap around the seat post or frame for leverage and stability **(c)**. Be sure to close the lever completely for maximum hold and to ensure the quick-release assembly remains in the closed position.

In the closed position, the lever should be more or less parallel to the bike, i.e. the lever should not stick out to the side.

The lever should come to rest close to the clamp and close to the frame so that it cannot be opened accidentally.

To check whether the clamp is sufficiently tight and the lever securely locked in place, try to rotate the lever in the closed position. Do this by applying pressure to the end of the lever as if to turn it in a circle.

If you can rotate the lever, the quick-release is not sufficiently tight and the seat post not securely held in place by the seat clamp. Open the lever again and screw the binder nut clockwise in small increments, closing the lever each time to see if clamping force has been increased sufficiently.

Check again to see whether the clamp is sufficiently tight by repeating attempts to rotate the closed lever. If the lever can no longer be rotated, the clamping force may now be sufficient.

Finally, check whether the seat post is being held firmly in place by taking hold of the saddle and attempting to twist the seat post inside the seat tube. If the seat post does not rotate inside the seat tube, the seat clamp should be sufficiently tight.

Quick-releases that have not been closed properly can cause parts to come loose.

 RITCHEY does not recommend using quick-release seat clamps in conjunction with carbon seat posts, because it is not possible to measure the torque applied to the seat clamp. Too much clamping force could damage a carbon seat post shaft, resulting in component failure, which could lead to an accident and potential injury.

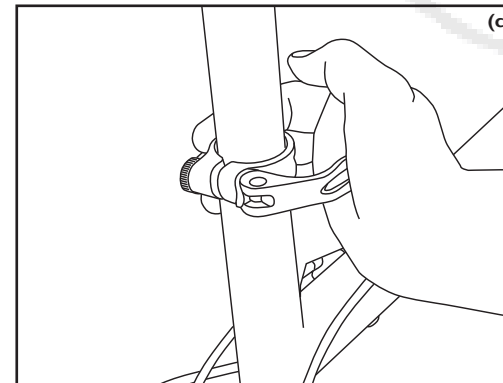
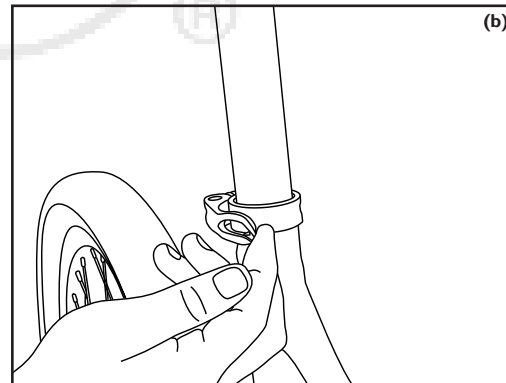
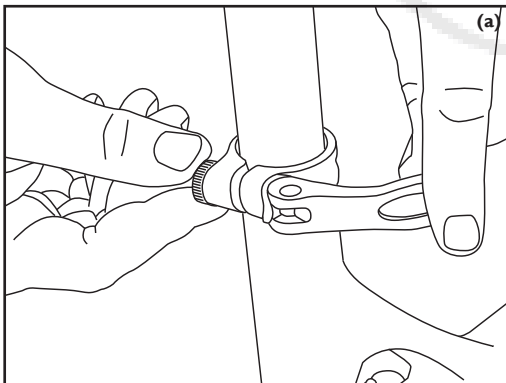

## Warranty Terms

Under European consumer law, the purchaser has full statutory warranty rights within the first two years from date of purchase. In North America, these rights apply to the first year from the date of purchase. According to these laws, your bicycle dealer is responsible for ensuring the product is free of defects that could cause premature wear from normal use.



The new European warranty law is valid in the countries where European (EU) regulations apply! Please ask your dealer about the regulations in your country!

Warranty claims will only be accepted if the bicycle has been used solely for its intended purpose (see section, "Before your first ride").

It does not cover damage resulting from wear, neglect (insufficient care and maintenance), accidents, overstress caused by overloading, incorrect installation, improper treatment or as a result of modifications made to the component.

Be sure to follow all assembly instructions in this manual precisely, as well as all additional instructions provided by the manufacturers of products used in conjunction with RITCHEY products, especially bolt torque specifications and prescribed maintenance. Observe all instructions with regard to procedures and verification processes listed in this manual, as well as any other instructions that may be included in the delivery of RITCHEY products. Also adhere strictly to any and all instructions pertaining to the replacement of safety relevant components, such as seat posts, stems, etc.

Your direct contact with regard to all issues outlined in this manual and corresponding instruction is your local RITCHEY dealer, who should be qualified to answer your questions. In order to obtain assistance from a RITCHEY dealer, you may be required to show your receipt.

**You must contact your reseller if you have a warranty issue or concern, i.e. the RITCHEY dealer who sold you the bicycle component in question.** RITCHEY has exclusive agreements with all of its reseller partners to service potential warranties. If you purchase a RITCHEY product from an unauthorized reseller (e.g.: an auction site at the internet), you have no recourse through RITCHEY or any of its authorized resellers, so you must seek resolution with the reseller who sold you the product.

## A Note on Wear

Bicycle components are subject to wear due to normal and proper use. The rate of wear will depend on care and maintenance, the bike's usage and the environment it is exposed to, such as rain, mud, dust, and sand. Some components require regular care and maintenance, but despite the best maintenance program, all components will eventually reach the end of their serviceable life, depending on conditions and intensity of use.

The following RITCHEY part is especially subject to wear due to the nature of its intended use and not covered for wear under this warranty:

The saddle covering which is subject to compression, abrasion and soiling.

## Manufacturer's Guarantee

RITCHEY products have been developed and manufactured with great care and have gone through numerous testing controls. Our products are examined as part of our internal quality control process to meet strict standards, as well as by external, neutral test laboratories.

For the EU market we grant, independent of legal regulations, a voluntary guarantee that your RITCHEY product is free of manufacturing and processing defects for 2 years from the date of purchase.

For the North American Market we grant, independent of legal regulations, a voluntarily guarantee, that your RITCHEY product is free of manufacturing and processing defects for one year from date of purchase (excluding saddle surfaces, as clarified above.)

This manufacturer's guarantee only applies to claims made by the initial buyer, who must present the purchase receipt with date of purchase, dealer address and model number. Guarantee claims will only be accepted if the bicycle has been used in accordance with the intended use of RITCHEY products.

This guarantee does not cover damage resulting from:

- wear
- neglect (insufficient care and maintenance)
- accidents
- overstress caused by overloading
- incorrect installation or improper treatment
- changes or modifications to the component (e.g. cutting the seat post).



The instructions in this and all RITCHEY manuals are carefully designed to maximize the life of RITCHEY products. Any guarantees are void if installation instructions are ignored and/or if regular inspection and maintenance intervals are neglected.

In the case of a warranty claim, RITCHEY reserves the right to provide all or part of the current successor model in an available colour – or if such part is not available, a higher grade model – to remedy the claim. The guarantee does not cover assembly, refitting costs or any new accessories that may be required (e.g. different dimension parts).

The guarantee does not cover labour and transport costs, nor does it cover follow-up costs resulting from defects.

Your direct contact for any issue should be your RITCHEY dealer/reseller, who is authorized to respond to your inquiries.

Find contact information for your national distributor at [www.ritcheylogic.com](http://www.ritcheylogic.com)

RITCHEY International  
Via Cantonale 2  
CH- 6916 Grancia-Lugano

RITCHEY Design Inc. Taiwan Branch  
22-1, #123 Chungang Rd. Sec 3  
Taichung 407  
Taiwan R.O.C.

RITCHEY Corporate HQ's  
620 Spice Island Drive  
Sparks, NV 89431

RITCHEY Design Inc.  
Sales & Warranty Office  
575 Old County Road  
San Carlos, CA 94070

If you have any question, please ask your national distributor. You will find a distributors list at [www.ritcheylogic.com](http://www.ritcheylogic.com).

Technical details in the text and illustrations of this manual are subject to change.

© No part of this publication may be reprinted, copied or transmitted by hand or with mechanical or electronic systems or used for another business purpose without prior written permission.

### Concept and text:

Zedler – Institut für Fahrradtechnik und -Sicherheit GmbH  
[www.zedler.de](http://www.zedler.de)  
Edition 2, February 2012