

THULE[®]
SWEDEN

› Enjoy the ride

2014



Bring your life
thule.com



Racks	6	Water	62
Technology and features	8	Technology and features	64
Load bars	10	Water sport carriers	66
Load carrier feet	15	Technical specifications	68
Thule Professional	16		
		Winter	70
Cargo	18	Technology and features	72
Technology and features	20	Winter sport carriers	74
Roof boxes	22	Snow chains	76
Foldable roof boxes	30	Technical specifications	79
Carrier baskets	32		
Rear mounted cargo	34	More product information on	
Technical specifications	36	www.thule.com	
Bike	38		
Technology and features	40		
Roof mounted carriers	42		
Rear door mounted carriers	46		
Tow bar mounted carriers	50		
Bike travel cases	57		
Technical specifications	60		







➤ Testing the adventure

Adventure is a word with countless meanings. The members of Thule Adventure Team have their own way of expressing the word. They take part in some of the most challenging adventure competitions in the world.

Their passion is simply called multisport. It's a phenomenon that consists of a number of different disciplines, like paddling, climbing and cross-country running. Every single competition has a mix of a few disciplines, and will often go on for 10-11 days. In other words, an extreme test of endurance, self-discipline and long, hard teamwork. Thule Adventure Team was brought together in 2009 and has shown their capacity on several occasions. The most stunning performance took place in 2011, as the team won the World Championships in the rough terrain of Tasmania, Australia. The success was almost repeated in the 2012 championships, but they finished in second place after another impressive effort.

IT'S FOR REAL

Thule Adventure Team compete with different types of gear like bikes and kayaks for example. Even if transporting their

equipment is a slightly different challenge compared to their competitions, they always need reliable loading solutions. Thule Adventure Team use Thule racks, roof boxes and bags when travelling to the starting line. From our point of view, there is no better way of testing our products in real life.

A COMPLETE STRAIN

We have also created a real but extreme environment in our test centre. Inside you will meet every possible weather, temperature and terrain that is out there. The products will be exposed to icy northern cold, desert heat, intensive UV radiation, a salt chamber for corrosion endurance and several pressure and capacity tests. Finally we use a machine that shakes the products for a lifetime's worth, simulating two trips around the world in less than a week.

CREATING OWN STANDARDS

Our purpose is to push all new products to the limit, and even pass it. Even though we made it our mission to simplify your active life with our innovative products, safety is more important than all other features. We exceed the standards and we will keep doing that. It is the only way for us to remain international leaders in safety and durability.



THULE CREW

Our adventure team members are not the only ones out there testing Thule products. We have increased our collaboration with individuals who love to perform at levels way above normal. These chosen athletes are all part of a group that we call Thule Crew. And it is indeed a crew of its own. One member has the record for the largest wave ever surfed. Another has performed the first ski BASE jump off the Matterhorn, Switzerland. A third is one of the greatest alpine skiers of all time. Our products are in their hands for their security. And yours.

Members of Thule Crew



Eva Nyström. Triathlon. World Champion in duathlon 2012.



Garrett McNamara. Surfing/SUP. Record holder for largest wave ever surfed.



Jenny Rissveds. Cycling. Gold medal winner at the European Championships 2013.



Flo Orley. Snowboarding. Vice World Champion Freeride World Tour 2011.

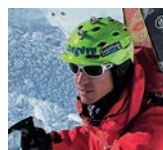

Matthias Giraud. Skiing/BASE jumping. Performed the first ski base jump off the Matterhorn.

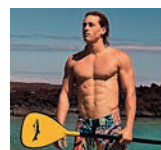

Niccolo Porcella. SUP/Kitesurfer. Iconic waterman and kitesurfer.



Chris Van Dine. Biking. Famous adventurer and gravity star.



Tim Johnson. Cycling. Six-time US National Champion.

The world of Thule

Take a look at the world of Thule. Our wide range of products, Fit Guide, dealer locator and more useful information are available at our website. You can also visit us at Facebook or be inspired at our Youtube channel.

www.thule.com
www.facebook.com/thulebringyourlife
www.youtube.com/thulebringyourlife

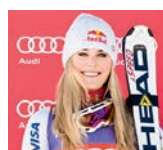

Lindsey Vonn. Alpine ski racer. World champion and Olympic gold medalist.



Pedro Olivia. Kayaker who has performed the highest waterfall drop ever - 38 metres.



Yoshitaku Nagasako. Biking. Famous and spectacular BMX rider.



Thule Adventure Team. Multisport. Adventure Racing World Champions 2011 & 2013.



> Racks







› The fastest way out there.

The number of family members, like the number of outdoor activities, tend to increase with time – and space in the car is reduced accordingly. One way to make room for more adventure is to load things on your car roof.

Start by choosing a rack that suits your needs. A Thule roof rack is the strong foundation for every load, and you can easily mount accessories for different purposes. Just a few simple operations and you're on your way.





FEATURES

1 The innovative Thule SlideBar makes loading heavy items simple. And because it slides out beside the car body, it protects your car from damage and you from getting dirty. **2** Thule WingBar Edge offers a universal fit thanks to the use of telescopic feet, that are adjustable with up to 50 mm/side. **3** In most Thule rack systems all tools are integrated, so there's no risk of leaving them at home. **4** For T-track owners, this provides an elegant alternative to tightening anything around the bar. **5** Avoid the hassle with many different keys, upgrade to Thule One-Key System and get one key for all Thule products. Available in sets of 4, 6, 8 and 12 locks. Check www.thule.com for more information.



> 1: What is your need?

Everyday, sometimes or just now and then? Heavy or light gear? We have a rack for all purposes.



Thule WingBar Edge

If your need of loading gear on your car varies from time to time, but you wish that possibilities will always be there, Thule WingBar Edge offers the ultimate solution. The extra low profile and close fit to the roof makes your car look even better, even when not in use. At the same time, Thule WingBar Edge is safe and basically noiseless.

MORE INFO, SEE PAGE 12.



Thule WingBar

Want to use your bar often and leave it mounted on your car when not in use? The lightweight aluminium Thule WingBar might be the perfect choice. The loading capacity is higher, and still the bar is basically noiseless. Its T-track allows you to use the full width of the bar and easily fit load accessories.

MORE INFO, SEE PAGE 13.



Thule SlideBar

If you're going to transport sports equipment such as kayaks or bikes, if you have a bulky load, or if you have a high car, take a look at the innovative Thule SlideBar. The bar slides out on either side of the car body so you can easily manage your load. Suitable for an active life where loading and unloading are frequent elements.

MORE INFO, SEE PAGE 14.

Thule SquareBar

If you only use your bar once in a while, the standard Thule SquareBar, made of steel and coated in black plastic for a durable finish, might be right for you.

Thule Professional Bar

Craftsmen have special needs, and we have a special bar – the sturdy Thule Professional Bar, with a unique tri-slot design for fitting multiple accessories.



FOR MORE INFORMATION ABOUT THE THULE PROFESSIONAL RANGE, SEE PAGE 17.

> 2: Your car.

Remember that car roofs don't look the same. Pick the load carrier that fits your car. Thule Fit Guide at www.thule.com, or the printed FitGuide available in shops, will help you find the perfect solution to your needs.

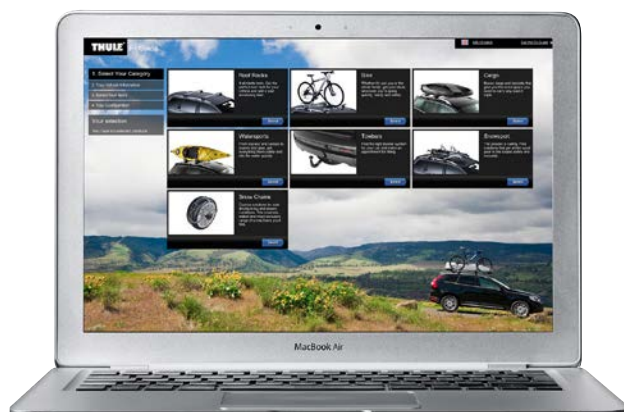

Load carrier foot for cars with preinstalled fixpoints.



Load carrier foot for cars with roof rails.



Load carrier foot for cars with flush railings.



Load carrier foot for cars with normal roofs.



Thule WingBar Edge

Close to perfection - the most safe and silent roof rack, now in low fit. The Thule WingBar Edge produces just 6% of Thule AeroBar's noise. In other words, it's practically noiseless. The low profile and close fit to the roof creates a stunning look, also making it safer when driving under low passages.

FEATURES

- 1 Universal fit by the use of telescopic feet (50 mm/side).
- 2 Lightweight. Thule WingBar Edge is made of lightweight aluminium and safely carries loads up to 75 kg.
- 3 Thule WingBar Edge 958X for cars with roof railings.
- 4 Thule WingBar Edge 959X for cars with pre-installed fixation points.
- Easy handling with the pre-assembled system and integrated foot.
- T-track for fast mounting of accessories.
- WindDiffuser diverts the air currents.
- TrailEdge for reduced air resistance.
- 55% drag force reduction compared to Thule AeroBar.
- City Crash approved for 75 kg (ISO).



2013

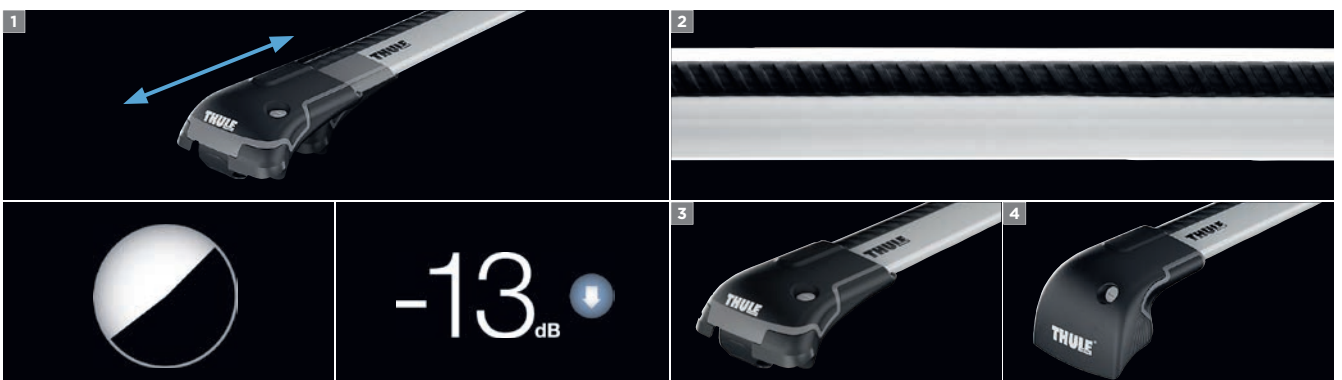



Thule WingBar

Inspired by aircraft wings, the Thule WingBar is safe, stylish, aerodynamic and extremely silent. Compared to its predecessor, the sound energy has been reduced by 90% and the air resistance by 55%. In addition to the elegant design, it also has great loading capacity and carries up to 100 kilos.

FEATURES

- 1 WindDiffuser diverts the air currents.
- 2 T-track for fast mounting of accessories.
- 3 TrailEdge for reduced air resistance.
- 4 WingPlug for easy access to the T-track.
- 5 SmartSlide - an innovative track cover with length scale (patent pending).
- Smoothly curved aerodynamic profile.
- City Crash approved for 100 kg (ISO).
- Lightweight aluminium.

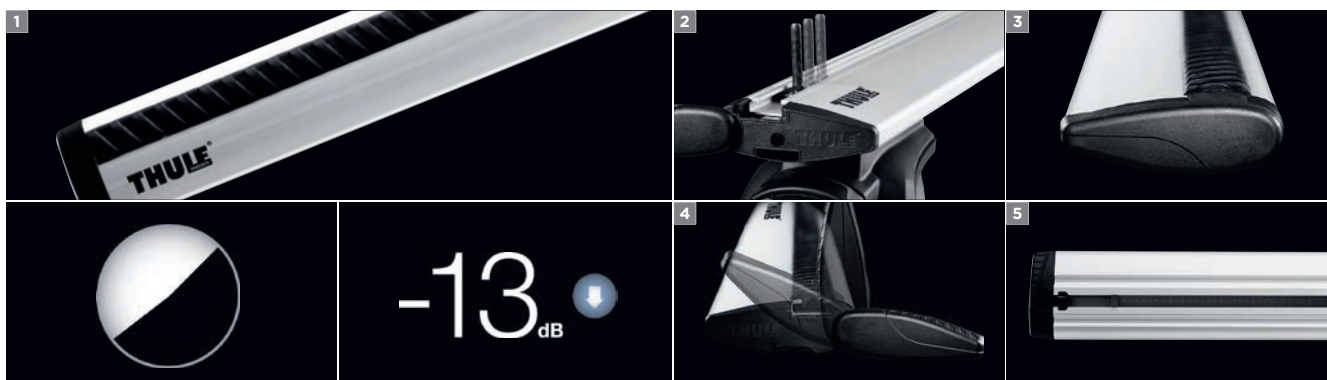



Thule SlideBar

The innovative Thule SlideBar makes loading heavy items simple. And because it slides out on either side of the car body, it protects your car from damage and you from getting dirty.

FEATURES

1 Extended by 600 mm on both sides to enable everyone to access whole rack. **2** Colour indication shows open or closed position for maximum safety. **3** Rubberised grip panels, giving an extra secure grip when using the slide-function. **4** T-track for fast mounting. Load accessories are easily slid in place into the T-track. **5** Thule Eye Bolt 320. If you're going to mount your carrier on a Thule SlideBar, you might need a Thule Eye Bolt in order to use the slide function. ■ Fail-safe automatic snap-lock. ■ Locking cylinder on both sides which enables the user to lock the system against unauthorised use. ■ City Crash approved.



reddot design award
winner 2011



Load carrier feet

Roof type	Normal roof	Fixpoint/Flush railing		Fixpoints
Name	Thule Rapid System 754	Thule WingBar Edge 959X	Thule Rapid System 753	Thule Rapid System 751
Description	The most secure and exclusive roof rack for cars without railings or fixation points.	A complete & pre-assembled roof rack with extra close fit to the roof. Designed for cars with pre-installed fixation points or flush railings.	An elegant, universal roof rack foot for cars with pre-installed fixation points or flush railings.	A smart universal roof rack foot for cars with pre-installed fixation points.
Load capacity (kg)¹	75	75	100	100
Foot height (cm)²	9.6	5.9	7.2	10.5
Lock	•*	•	•	•
Fits WingBar	•	•	•	•
Fits SlideBar	•	•	•	•
Fits AeroBar	•	•	•	•
Fits SquareBar	•	•	•	•
Fitting kit needed	•	•	•	•
TÜV approved	•	•	•	•
Fulfils City Crash norms	•	•	•	•

* Thule Rapid System 754 foot packs produced after February 2013 is containing locks. See product packaging for more information.

Roof type	Roof rails				Rain gutter
Name	Thule WingBar Edge 958X	Thule Rapid System 757	Thule Rapid System 775	Thule SmartRack 784/785 794/795	Thule 951/951-2
Description	A complete & pre-assembled roof rack with extra close fit to the roof. Designed for cars with roof rails.	The world's best selling load carrier for cars with normal-sized roof railings.	The universal, elegant railing rack that fits the broadest range of railing dimensions.	A universal, easy to use complete packed railing rack.	A classic roof rack for cars with rain gutters.
Load capacity (kg)¹	75	100	100	75	100
Foot height (cm)²	4.1	7.5	6.5	7.5	15
Lock	•	•	•	• (See Misc)	Accessory 527
Fits WingBar	•	•	•	•	• (951-2)
Fits SlideBar	•	•	•	•	• (951-2)
Fits AeroBar	•	•	•	• (794/795)	• (951-2)
Fits SquareBar	•	•	•	• (784/785)	•
Fitting kit needed					
TÜV approved	•	•	•	•	•
Fulfils City Crash norms	•	•	•	•	•
Miscellaneous	Complete pack. Fits railing sizes between 25-60mm	Fits railing sizes between 22-55 mm.	Fits railing sizes between 20-68 mm.	Fits railing sizes between 18-50 mm. Lockable with special tool.	Also available for cars with raised roof, foot packs 952/952-2 and 953/953-1

¹ Maximum load is the maximum approved weight for each type of roof rack. Consult your car manual and the Thule fitting instruction for your car's maximum load limit.

² Foot height is the distance from the base of the foot to the contact surface of the bar.

Please note that:

- For distances to the top of the bar, add 22 mm for Thule SquareBars, 27 mm for Thule AeroBars, 27 mm for Thule WingBars, and 48 mm for Thule SlideBars.
- The car specific fitting kit is excluded in the height measurement.

Load carrier feet are available as 4-packs and load bars as 2-packs.

> Thule Professional





Thule load-stop 314
Strong load-stops developed in partnership with skilled craftsmen. The load-stops are easy to move and adjust according to the load.



Thule fold down load-stop 315
Keeps the load firmly in place, while offering a unique folding capability, so that it can be tilted down when not in use or when loading.



Thule ladder carrier 548
Holds up to 3 ladders in place. Includes 3 load-stops.



Thule ladder holder 330
Flexible and easy-to-use loading accessory. Carries up to three section ladders.



Thule ladder tilt 311
Designed with an innovative extender function that tilts down along the side of the vehicle, making loading and unloading remarkably quick, easy and safe. A ratchet mechanism with a wide and durable rubber strap ties down the ladder comfortably and safely.



Thule conduit box 3171
Designed with double openings making loading and transporting pipes amazingly quick and easy.



Thule roller 815
Roller mechanism makes it easier to slide long objects onto the car roof. Ideal for loading longer objects like ladders or timber. The roller is rubber-coated for protection during loading. Can also simplify the loading of kayaks or surfboards.



This is a selection of our durable and time-saving solutions for professional use. Discover all our work solutions in the Thule Professional catalogue or at www.thule.com.

Name	Thule load-stop		Thule fold-down load-stop	Thule ladder carrier	Thule ladder holder	Thule ladder tilt	Thule conduit box	Thule roller	Thule roller
	502/ 503	314	315	548	330	311	3171	815	334/335
Height (cm)	25/9	15	17				12		
Length							320	65	65/110
Lock	Accessory 538	Accessory 538		•			•		
Fits WingBar Edge ¹		•	•						
Fits WingBar ¹		•	•						
Fits SlideBar ¹		•	•		•				
Fits AeroBar ¹		•	•		•		Accessory 346	•	
Fits SquareBar	•			•			Accessory 346	•	
Professional bar		•	•		•	•	•		•
TÜV approved	•	•		•	•	•	•	•	•
Miscellaneous	4 movable load-stops.	2 movable load-stops.	2 folding load-stops	Holds up to 3 ladders in place. Includes 3 load-stops.	Holds up to 3 ladders (50 kg). Includes 4 load-stops and a ladder fixation mechanism.	Tiltable. Holds up to 3 ladders (50 kg). Includes 4 load-stops and a ladder fixation mechanism.	Load capacity 50 kg. Pullwire 3181 allows you to separate short and long pipes.	Width: 65 cm. Aluminium profile, covered with soft plastic (TPE) surface.	Mounts to the rear track of the Thule Professional bar.

¹ Applies when using Thule's original carrier. Please consult your Thule dealer before using another manufacturer's carrier.

> Cargo







› Just as safe as good looking.

As all Thule products, cargo systems are tested for safety that far exceeds international requirements. Safety is a matter of necessity, but it doesn't mean that you have to give up good design. We always keep a close eye on the car industry – especially the latest designs – because we want your roof box to both fit your car and suit it. But at the centre of our thinking is you. Our roof boxes, foldable roof boxes, and other cargo carriers are all extremely user-friendly, easy to attach, and full of useful features. You will benefit more from travelling than ever before.





FEATURES

- 1** Automatic load fixation: by just closing the box lid, the load will be fixed and secured automatically with the new integrated loading net and crash nose.
- 2** Exclusive 2-tone colour combination.
- 3** PowerClick. Patented pre-installed quick mounting system with integrated torque indicator. Standard on Thule Excellence, Thule Dynamic, and Thule Motion.
- 4** DualSide. Allows you to open the box from both sides, for easy mounting, loading and unloading. Standard on Thule Excellence, Thule Dynamic, Thule Motion, and Thule Touring.
- 5** Central locking. Patented safety locking system - the key can only be removed if all locking points are closed. Standard on all Thule boxes with side opening.
- 6** Foldable for easy transport and minimal storage space. Standard on Thule Ranger.

> Roof boxes





Thule Excellence XT

On top when it comes to easy packing and design. A roof box that combines superior functionality in the form of innovative, safe and smart features with a fresh, individualistic look.

FOR SPECIFICATIONS, SEE PAGE 36.
AVAILABLE SIZES AND COLOURS, SEE PAGE 27.

FEATURES

- 1 Automatic load fixation.
- 2 2-tone colour combination.
- 3 Patented PowerClick quick-mount system, for fast and secure fitting using one hand only.
- 4 DualSide opening for convenient mounting, loading and unloading.
- 5 Central safety locking system with Thule Comfort key.
- 6 Advanced aerodynamics with diffuser technology and spoilers.
- 7 Inside and outside handles for convenient opening and closing.
- 8 Lid cover to protect the box from scratches and dust during storage.
- 9 Thule Box light.





Thule Dynamic

The most sporty, aerodynamic and sleek roof box. Harmonises in a great way with modern car designs thanks to the roof-hugging, streamlined design, and is combined with top class functions.

FOR SPECIFICATIONS, SEE PAGE 36.
AVAILABLE SIZES AND COLOURS, SEE PAGE 27.

FEATURES

- 1 Low, aerodynamic design.
- 2 Patented PowerClick quick-mount system, for fast and secure fitting using one hand only.
- 3 DualSide opening for convenient mounting, loading and unloading.
- 4 Central safety locking system with Thule Comfort key.
- 5 Advanced aerodynamics with diffuser technology and spoilers.
- 6 Outside handles for convenient opening and closing.
- 7 None-slip base mat for extra load securing.





Thule Motion

Comes with the most spacious, and aerodynamically optimised design. The roof box that combines the most litre volume and best space efficiency with greatest functionality.

FOR SPECIFICATIONS, SEE PAGE 36-37.

AVAILABLE SIZES AND COLOURS, SEE PAGE 27.

FEATURES

- 1 Spacious and space efficient design.
- 2 Patented PowerClick quick-mount system, for fast and secure fitting using one hand only.
- 3 DualSide opening for convenient mounting, loading and unloading.
- 4 Central safety locking system with Thule Comfort key.
- 5 Outside handles for convenient opening and closing.

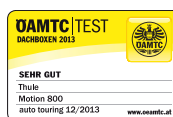



Thule Touring

Functional roof box for all your needs, Thule Touring offers a wide selection of sizes and suitable loading capacity. Combined with modern design and smart functions, this is the right box for your specific demands.

FOR SPECIFICATIONS, SEE PAGE 37.
AVAILABLE SIZES AND COLOURS, SEE PAGE 27.

FEATURES

- 1 Available in exclusive black glossy or in extravagant titan aeroskin colour.
- 2 Patented FastClick quick-mount system with integrated torque indicator for easy and secure fixation.
- 3 DualSide opening for convenient mounting, loading and unloading.
- 4 Central safety locking system with Thule Comfort key.



> Sizes and colours.

Thule Excellence XT	Thule Dynamic	Thule Motion	Thule Touring

XXL

Thule Motion 900



235x94x47 cm. 630 l.

XL

Thule Excellence XT



218x94x40 cm. 470 l.

Thule Motion 800



205x84x45 cm. 460 l.

Thule Touring 700



232x70x42 cm. 430 l.

Thule Touring 780



196x78x43 cm. 420 l.

L

Thule Dynamic 900



235x94x35 cm. 430 l.

Thule Motion 200



175x86x46 cm. 410 l.

Thule Touring 200



175x82x45 cm. 400 l.

M

Thule Dynamic 800



206x84x34 cm. 320 l.

Thule Motion 600



190x67x42 cm. 320 l.

Thule Touring 600



190x63x39 cm. 300 l.



S

Thule Touring 100



139x90x40cm. 330 l.



Add to your roof box



Thule Boxlift 571

With the Thule Boxlift, you can easily lift up your roof box to the garage ceiling. The lift works just as perfectly for kayaks and surfboards.

Thule Box lid cover

Take care of your roof box when you store it at home. The Thule Box lid cover is made of soft fleece material and protects against dirt and scratches. Available in 3 different sizes. See page 36-37 to find the cover that fits your Thule roof box perfectly. Also fits most older Thule roof boxes.



Thule T-track adapter

For T-track owners, this provides an elegant alternative to tightening anything around the bar. And by using the slide function, you can use the full width of it too. Different variants available, depending on roof mount mounting system and T-track dimension. Check www.thule.com for more information.



Thule One-Key System

Avoid the hassle with many different keys, upgrade to Thule One-Key System and get one key for all Thule products. Available in sets of 4, 6, 8 and 12 locks. Check www.thule.com for more information.





Thule Go Pack Set 8006

Four-pack including three Thule Go Packs 8002 and one Thule Go Pack Nose 8001. Designed to fit your Thule roof box.



Thule Go Box 8005

The two partitions make it a practical organiser in the trunk or in your home, perfect for all kinds of gear. Foldable for easy storage when not in use. Can be folded for one compartment use only. When folded only 30 mm thick. Size 61x34x31 cm.



Thule Go Pack 8002

Protective rubber pads in the corners. Shoulder strap and grips for comfortable handling. Size 61x33x31 cm.



Thule Go Pack Nose 8001

Specially shaped to make use of the tighter space in the front of the roof box. Protective rubber pads in the corners. Shoulder strap and grips for easy and comfortable handling. Size 61x42x28 cm.



Thule Box Ski Carrier adapter

Want to transport your skis safely and in style? We recommend using the Thule Box Ski Carrier to keep the skis in order inside the box. Just select the right ski carrier for your box model. Available in 5 different sizes. See page 36-37 to find the adapter that fits your Thule roof box perfectly.



Thule Box light 6951

Make sure to get optimal visibility inside the box with Thule Box light. Special designed LED lamp and customised reflector with automatic on/off function when closing or opening box.

➤ Foldable roof boxes





Thule Ranger 90.



Thule Ranger 500.

Thule Ranger

A foldable solution for easy transport and storage – turns into a small package that fits in the boot of the car. Made of waterproof material, with welded seams and a sealed zipper with integrated lock.

FEATURES

- 1 EasySnap quick mounting system for easy fitting of the box, no tools required.
 - 2 Special bag for storing the rolled-up box is included (Thule Ranger 90).
 - 3 Extension areas with zippers to adjust the loading space to the size of the load (Thule Ranger 500).
 - 4 Ski carriers for secure ski transport included (Thule Ranger 500).
- Colours: black – silver-grey. ■ Loading capacity up to 50 kg.

FOR SPECIFICATIONS, SEE PAGE 36.



Easy to store

Thule Ranger requires minimal storage space – you can even fit it in your wardrobe.



Carry it under your arm

A specially designed bag makes it very simple to carry the box wherever you want.



Roll it out

Just place it onto the load carrier, roll it out and mount. Ready to load!

➤ Carrier baskets





Thule Trail

This premium carrier basket combines exclusive design and first-class materials. Integrated innovative functionalities make handling easy and offer great possibilities to extend the utilization of the carrier basket.

FOR SPECIFICATIONS, SEE PAGE 37.

FEATURES

- 1 Integrated side consoles for enforced security.
- 2 Integrated T-track in front and rear profiles for adding other Thule products with perfect fit. Alternative use as flat loading surface with non-slip rubber padding, for transporting long loads.



Thule load net and Thule GoPack bags are available as separate accessories.



Thule load net and Thule GoPack bags are available as separate accessories.

Thule Xplorer

Reliable carrier basket that is easy to handle. Sturdy aluminium design.

FEATURES

- Six eyes for straps/load net make it easy to tie down the load.
- Available in three sizes.

FOR SPECIFICATIONS, SEE PAGE 37.

Thule Xperience

With robust, built-in, lightweight tubular steel and smooth, black finish, this carrier basket is an experience itself.

FEATURES

- 1 Adjustable load bars allow attachment of bike, ski and water sport carriers onto the basket.
- 2 Equipped with a fairing for improved aerodynamics.

FOR SPECIFICATIONS, SEE PAGE 37.

Add to your Thule carrier baskets



Thule load net

Expandable, with ten movable hooks. Great accessory for Thule carrier baskets. Available in two sizes:
Art. no. 595, 80x80 cm.
Art. no. 595-1, 130x90 cm.

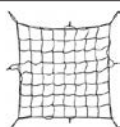

Thule Caravan 857

Optimize load organization on your Thule carrier basket with this 250 litres capacity bag. Environmental friendly PVC free construction, weather resistant material and taped seams. Fixed with integrated straps. When not in use it simply folds up and packs away in an included carrying bag. 101x81x45 cm.



➤ Rear mounted cargo



Thule EasyBase

The flexible four-in-one transport solution.

FEATURES

- Platform made of strong metal tubes. ■ Patented coupling fits all types of towbars, and needs no adjustment.
- U-bar easily folds down for easy storage. ■ Expands with Thule EasyBase accessories. ■ Load capacity 45 kg.



Start with the Thule EasyBase – and tailor it to your needs.



Thule EasyBike 948-1/948-2

Easily fitted by hand straight onto Thule EasyBase – no tools required. For all sizes of bikes, can be combined to carry a maximum load of three bikes. Easy to load and keeps bikes firmly secured. 948-1 carries one bike. 948-2 carries two bikes.



Thule BackUp 900

Easily fitted by hand straight onto Thule EasyBase – no tools required. Robust luggage box, which gives the car 420 litres of extra space. Perfect if you want to use the car roof for a different load or when you want to carry bulky items that need protection. Can also be fitted to Thule EuroClassic Pro 902/903 and Thule BackPac 973.



Thule EasyBasket 948-3

Easily fitted by hand straight onto Thule EasyBase – no tools required. With its generous dimensions, it will load everything from the lawn mower to bags with autumn leaves. Perfect for bulky, damp or dirty loads.



Thule EasyBag 948-4

Fitted straight onto Thule EasyBase using strong straps – no tools required. Measures 110x55x53 cm, ideal for sportswear, sports equipment, etc. Made of waterproof material, with taped seams and a zipper with integrated lock. Special storage bag included.

Name	Thule EasyBase	Thule EasyBike		Thule BackUp	Thule EasyBasket	Thule EasyBag
	949	948-1	948-2	900	948-3	948-4
Size (cm)	120x60x78			147x57x70	126x56x11	110x55x53
Max. number of bikes		1	2			
Load capacity (kg)	45	17	2x17	50	60	
Weight (kg)	15	1.6	3.2	14	6	4
TÜV/EuroBE approved	•	•	•	•	•	•
Fulfils City Crash norms	•	•	•	•	•	•
Miscellaneous	Rear lights. Locks carrier to car with accessory 957.	By combining 948-1 and 948-2 it is possible to transport 3 bikes. Fits frame dimensions 20-70 mm. Fits all wheel dimensions. Locks bike to carrier with accessory 526.		Volume 420 l. Rear opening. Mounting system 80 mm U-bolt. Colour grey.		Volume 315 l. Straps included. Taped seams and sealed zipper with integrated lock.

Roof boxes



Name	Thule Excellence XT	Thule Dynamic		Thule Motion	
		800	900	200	600
Size (cm)	218x94x40	206x84x34	235x94x35	175x86x46	190x67x42
Volume (l) ¹	470	320	430	410	320
Load capacity (kg)	75	75	75	75	75
Mounting system	PowerClick	PowerClick		PowerClick	
Opening	DualSide	DualSide		DualSide	
Straps	3	3	3	3	3
Central locking	•	•	•	•	•
Fits WingBar Edge	•	•	•	•	•
Fits WingBar	•	•	•	•	•
Fits SquareBar ²	•	•	•	•	•
Fits SlideBar	Accessory 697500	Accessory 697500	Accessory 697500	Accessory 697500	Accessory 697500
TÜV/GS approved	•	•	•	•	•
Fulfils City Crash norms	•	•	•	•	•
Max pairs of skis or snowboards	6-8	5-7	6-8	5-7	4-6
Max length skis (cm)	200	180	205	155	175
Ski carrier	Accessory 694900	Accessory 694800	Accessory 694900	Accessory 694800	Accessory 694600
Box lid cover	Included	Accessory 698100	Accessory 698300	Accessory 698100	Accessory 698200
Colour	Exclusive 2-tone Black glossy - titan metallic/6119B Titan glossy - black glossy/6119T	Titan glossy/6128T Black glossy/6128B	Titan glossy/6129T Black glossy/6129B	Silver glossy/6202S Black glossy/6202B	Silver glossy/6206S Black glossy/6206B

¹ Inner product measurements, based on digital 3D engineering drawings.

² Applies when using Thule's original carrier. Please consult your Thule dealer before using another manufacturer's carrier.

Foldable roof boxes



Name	Thule Ranger	
	90	500
Size (cm)	110x80x40	190x50x30
Volume (l) ¹	280	260
Load capacity (kg)	50	50
Mounting system	EasySnap	
Opening	Side/rear	Single side
Ski carrier	2	2
Straps	•	•
Locking	•	•
Fits WingBar Edge	•	•
Fits WingBar	•	•
Fits SquareBar ²	•	•
Fits SlideBar	Accessory 697100	Accessory 697100
TÜV/GS approved	•	•
Fulfils City Crash norms	•	•
Max pairs of skis or snowboards	-	3-4
Max length skis (cm)	-	185
Colour	Black - silver-grey/6011	Black - silver-grey/6035

¹ Inner product measurements, based on digital 3D engineering drawings.

² Applies when using Thule's original carrier. Please consult your Thule dealer before using another manufacturer's carrier.

New



RACKS

> CARGO

BIKE

WATER

WINTER

Thule Motion		Thule Touring					
800	900	100	200	600	700	780	
205x84x45	235x94x47	139x90x40	175x82x45	190x63x39	232x70x42	196x78x43	
460	630	330	400	300	430	420	
75	75	50	50	50	50	50	
PowerClick		FastClick					
DualSide		DualSide	DualSide	Single side	DualSide	DualSide	
3	3	3	3	3	3	3	
•	•	•	•	•	•	•	
•	•	•	•	•	•	•	
•	•	•	•	•	•	•	
•	•	•	•	•	•	•	
Accessory 697500	Accessory 697500	Accessory 697400	Accessory 697400	Accessory 697400	Accessory 697400	Accessory 697400	
•	•	•	•	•	•	•	
•	•	•	•	•	•	•	
5-7	6-8	-	5-7	4-6	4-6	5-7	
190	220	-	155	175	220	180	
Accessory 694800	Accessory 694900	-	Accessory 694800	Accessory 694600	Accessory 694700	Accessory 694800	
Accessory 698100	Accessory 698300	Accessory 698100	Accessory 698100	Accessory 698200	Accessory 698200	Accessory 698100	
Silver glossy/6208S Black glossy/6208B	Silver glossy/6209S Black glossy/6209B	Titan aeroskin/6341T Glossy Black/6341B	Titan aeroskin/6342T Glossy Black/6342B	Titan aeroskin/6346T Glossy Black/6346B	Titan aeroskin/6347T Glossy Black/6347B	Titan aeroskin/6348T Glossy Black/6348B	

Carrier baskets

New



Name	Thule Trail		Thule Xplorer			Thule Xperience
	823	824	713	714	715	828
Size (cm)	135x90x18	160x100x18	132x85x8	93x85x8	132x104x8	136x104x20
Lock	•	•	Accessory 538			Accessory One-Key System
Fits WingBar Edge	•	•	With adapter 878			-
Fits WingBar	•	•	With adapter 878			-
Fits SlideBar	•	•	With adapter 878			-
Fits SquareBar	•	•	•	•	•	•
TÜV/GS approved	•	•	•	•	•	•
Fulfills City Crash norms	•	•	•	•	•	•
Miscellaneous	Aluminum. Points of attachment adjustable to the load carrier in length.		Aluminium. Points of attachment adjustable to the load carrier in length. Thule load net and Thule Go Pack bags available as accessories.			Includes a fairing and two cross bars. Thule load net and Thule Go Pack bags available as accessories.

> Bike







› Take your bike from start to finish.

Whether it's the thrill of racing downhill, the physical challenge of a long-distance race, or the peaceful relaxation of sightseeing that you long for, cycling is perhaps the ultimate way of experiencing the outdoors. On the way to your next ride our bike carriers will keep your bikes perfectly secured to your car. Let us worry about getting your bikes there - you worry about the ride.

The challenges shouldn't start until you get on your bike and start your ride!



Explanation of symbols



Maximum number of bikes possible to transport.



Bike carrier recommended for transport of E-bikes or other heavy bikes (max 30 kg).



ROOF MOUNTED BIKE CARRIERS, SEE PAGE 42

1 Patented AcuTight clamping head “clicks” when optimal hold is reached controlling the torque going into the bike frame. **2** Once the bike is placed in the carrier, it stays in position. That allows you to make all adjustments at convenient height without holding the bike.

REAR MOUNTED BIKE CARRIERS, SEE PAGE 46

■ If your car doesn't have a tow bar and you need to transport many bikes, this is the perfect solution. **3** Carries 2-4 bikes. **4** Foldable and easy to store.

TOW BAR MOUNTED BIKE CARRIERS, SEE PAGE 50

5 New improved, detachable frame holders with Thule AcuTight torque limiter knobs that “click” when optimal torque is reached. **6** Always full access to the trunk, even with bikes mounted on carrier.

➤ Roof mounted carriers





Thule Sprint 569

The Thule Sprint roof mounted bike carrier combines convenience and patented safety technologies, making it the most complete fork mount carrier for maximum bike protection. The Thule Sprint is our recommended choice for bikes with sensitive frames.

FOR ACCESSORIES, SEE PAGE 58-59.
FOR SPECIFICATIONS, SEE PAGE 60

FEATURES

1 Patented AcuTight clamping head "clicks" when optimal hold is reached controlling the torque going into the bike frame. **2** Road Dampening Technology (RDT) elastomers are imbedded in the rack attachments to absorb road shock and vibrations. **3** Ratcheting wheel strap with RDT secures the rear wheel without damaging the rim. **4** Wheel chock support for increased rear wheel security and stability. **5** Telescopic wheel tray for custom fit to bike and vehicle. ■ Lockable - bike to bike carrier, bike carrier to load carrier (locks included). ■ Carries bikes up to 17 kg. ■ T-track adapters (20x20 mm) are included for mounting on Thule WingBar Edge, Thule WingBar, Thule SlideBar, and Thule AeroBar.



Add to your Thule Sprint



Thule wheel bag 563 XL

Specially designed high-quality bag, with special padding, to protect the bike wheel during transport and storage.

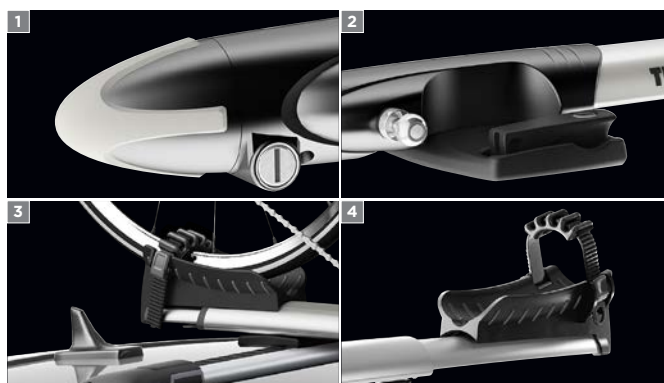



Thule ProRide

If you are looking for the best and most convenient roof mounted bike carrier the answer is the sleek, stylish, and award-winning Thule ProRide*. The uniquely designed wheel tray automatically positions the bike to the correct place allowing it to rest securely against the frame holder while you secure it. With the bike stable, the convenient height of the turning knob makes the final tightening quick and easy, getting you back on the road fast with minimal effort.

FOR ACCESSORIES, SEE PAGE 58-59.
FOR SPECIFICATIONS, SEE PAGE 60.

FEATURES

- 1 Quick-release straps with wheel protection hold the wheels securely in place. Adjustable for different wheel sizes.
 - 2 Can easily be fitted on either side of the car roof.
 - 3 Lockable - bike to bike carrier and bike carrier to load carrier.
 - 4 Fits bike frames up to 100 mm.
- Carries bikes up to 20 kg. ■ 20 mm T-track adapters included for mounting on Thule WingBar Edge, Thule WingBar, Thule SlideBar, and Thule AeroBar.



*Test winner of roof mounted bike carriers in tests performed by the renowned German consumer test institute StIWA (2004 & 2011), the German automobile club ADAC (2011) and the German BIKE magazine (2012).

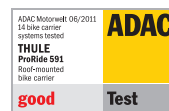

Add to your Thule ProRide



For extra security use the Thule cable lock 538

A plastic coated 180 cm long steel cable to secure your bike to the bike carrier for extra theft protection.





Thule OutRide

It's the details that make you a pro even when you are behind the wheel. Nothing says professional cyclist more than our sleek fork mount bike carrier, the Thule OutRide. A light, convenient, aluminum bike carrier also suitable for bikes equipped with disc brakes.

FEATURES

- 1 Easily adjustable snap-on fastener for all types of forks.
 - 2 Quick-release strap for rear wheel, adjustable for different wheel sizes.
 - 3 Adapter for bikes with 20 mm through-axles included.
 - 4 Lockable - bike to bike carrier and bike carrier to load carrier.
- Carries bikes up to 17 kg.
 - 20 mm T-track adapters included for mounting on Thule WingBar Edge, Thule WingBar, Thule SlideBar, and Thule AeroBar.

FOR ACCESSORIES, SEE PAGE 58-59.

FOR SPECIFICATIONS, SEE PAGE 60.



Thule FreeRide

If you are looking for a no-frills roof mounted bike carrier the Thule FreeRide is your answer. This carrier is pure function which makes it simple and easy to use, fulfilling all your basic needs and making your trip easy from start to finish.

FEATURES

- 1 Frame holder with quick-lock, fits most frame sizes up to 80 mm.
- 2 Quick-release straps with wheel protection hold the wheels securely in place. Adjustable for different wheel sizes.
- 3 Lockable - bike to bike carrier and bike carrier to load carrier.
- 4 20 mm T-track adapters included for mounting on Thule WingBar Edge, Thule WingBar, Thule SlideBar, and Thule AeroBar.

FOR ACCESSORIES, SEE PAGE 58-59.

FOR SPECIFICATIONS, SEE PAGE 60.

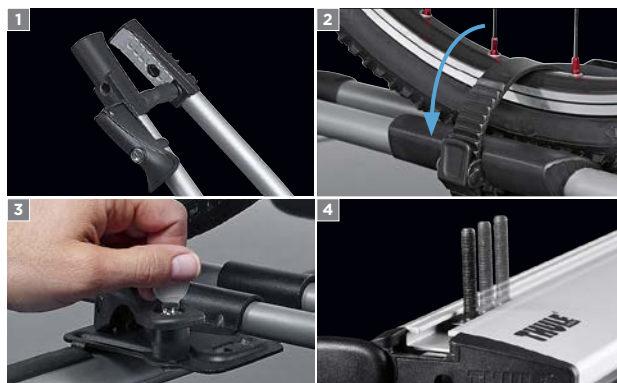
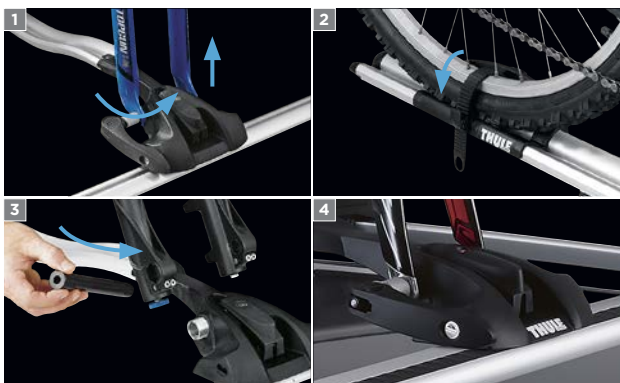

➤ Rear door mounted carriers





Thule RaceWay 991/992

The revolutionary Thule RaceWay is our strongest, most secure and easiest to use rear door mounted bike carrier. Available in two versions: Thule RaceWay 991 for two bikes and Thule RaceWay 992 for three bikes.

FEATURES

1 Sure-Tight steel ratcheting cables provide maximum fastening security to your vehicle. **2** Patented FitDial knobs guarantee a "perfect fit" to your vehicle. **3** Premium cradles with RDT (Road Dampening Technology) secure the bike to the rack while absorbing road shock. **4** Molded rubber pads provide firm hold to vehicle and protect against scratches. **5** Patented No-Sway cages prevent bike-to-bike and bike-to-vehicle contact. **6** Narrow cradle arms hold a variety of bike frames, including smaller children's bikes and fold when not in use. **7** Folds flat for easy transport and convenient storage. **8** Lockable bike-to-carrier and carrier-to-vehicle (locks included).

See the [Thule Fit Guide](#) or www.thule.com for car recommendation list.

FOR ACCESSORIES, SEE PAGE 58-59.

FOR SPECIFICATIONS, SEE PAGE 61.



Add to your Thule RaceWay



Thule bike frame adapter 981

Telescoping adapter for easiest possible fitting of bikes with non-standard frames, ladies' bikes, BMXs, downhill bikes, etc.

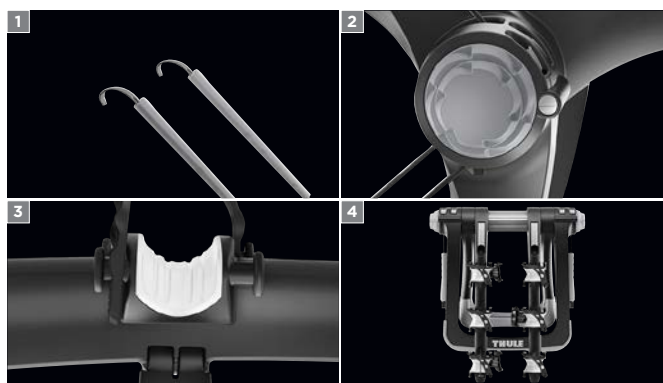



Thule BackPac

A high standard carrier with flexibility designed for vans, minibuses and MPVs. The carrier's high position on the car keeps the rear lights and the number plate visible with bikes mounted. By adding adapters you can expand the carrier's capacity to three or four bikes.

FEATURES

- A special kit adjusts the carrier to fit a number of vehicle models.
- All parts in contact with the car and bikes are coated with rubber for extra protection.
- 1 All bike frame holders are detachable for convenient mounting of bikes.
- 2 Quick-release straps, adjustable for different wheel sizes.
- 3 Carries two bikes, or three to four bikes with adapters.
- Extendable wheel trays for large bikes.
- Folds flat for easy storage and handling.
- Outer bike position lockable to carrier, carrier lockable to car with Thule lock 567.

See the **Thule Fit Guide** or www.thule.com for car recommendation list.

FOR ACCESSORIES, SEE PAGE 58-59.

FOR SPECIFICATIONS, SEE PAGE 61.



Add to your Thule BackPac



Need to transport one or two extra bikes?

With the Thule adapter 973-23 the capacity of Thule BackPac increases from two to three bikes, and with adapter 973-24 from three to four bikes.



Thule ClipOn High

A fast mounting and foldable 2-bike carrier designed for station wagons and hatchbacks. The carrier's high position on the car keeps the rear lights and the number plate visible with bikes mounted.

FEATURES

- All parts in contact with the car and bikes are coated with rubber for extra protection.
- Easy to mount to the rear door with a unique snap-on system.
- Quick-release straps, adjustable for different wheel sizes.
- Extendable wheel trays for large bikes.
- Quickly folds for easy storage.
- Outer bike position lockable to carrier.

See the [Thule Fit Guide](#) or www.thule.com for car recommendation list.

FOR ACCESSORIES, SEE PAGE 58-59.

FOR SPECIFICATIONS, SEE PAGE 61.



Thule ClipOn

A snap-on 3-bike carrier with smart features, perfect for station wagons and hatchbacks.

FEATURES

- All parts in contact with the car and bikes are coated with rubber for extra protection.
- Easy to mount to the rear door with a unique snap-on system.
- Quickly folds for easy storage.
- Possible to attach Thule Light board 976.

See the [Thule Fit Guide](#) or www.thule.com for car recommendation list.

FOR ACCESSORIES, SEE PAGE 58-59.

FOR SPECIFICATIONS, SEE PAGE 61.



Thule FreeWay

A basic rear-door mounted 3-bike carrier designed for hatchbacks and sedans.

FEATURES

- All parts in contact with the car and bikes are coated with rubber for extra protection.
- Possible to attach Thule Light board 976.

See the [Thule Fit Guide](#) or www.thule.com for car recommendation list.

FOR ACCESSORIES, SEE PAGE 58-59.

FOR SPECIFICATIONS, SEE PAGE 61.



➤ Tow bar mounted carriers





Thule EasyFold

Our most convenient rear mount bike carrier for all types of bikes. With a simple two-step operation, mount the carrier on the tow bar, unfold it and it's ready to use, all in a matter of seconds. If space is your issue the Thule EasyFold features the smallest folded size in our line making it perfect for a wide variety of storage options.

FEATURES

1 UPDATE: New improved, detachable frame holders with Thule AcuTight torque limiter knobs that "click" when optimal torque is reached (for 22-80mm round and oval frames). **2** Fully foldable for convenient mounting, handling and storage. ■ High load capacity enabling transport of E-bikes/Pedelecs. ■ Large distance between wheel holders for more clearance between the bikes. ■ Smart foot pedal tilt for easy trunk access even with bikes mounted. **3** Adjustable one hand coupling with low closing force for easy mounting of carrier. ■ Pump buckles with long wheel straps for easy fastening of wheels. **4** Integrated carrying handles for ergonomic transport of the carrier. ■ Carrier lockable on tow bar and all bikes lockable to carrier.

FOR ACCESSORIES, SEE PAGE 58-59.

FOR SPECIFICATIONS, SEE PAGE 60.



Add to your Thule EasyFold



Thule EasyFold Carrying Bag 9311

Protecting you and your car from dirt when transporting and storing the Thule EasyFold

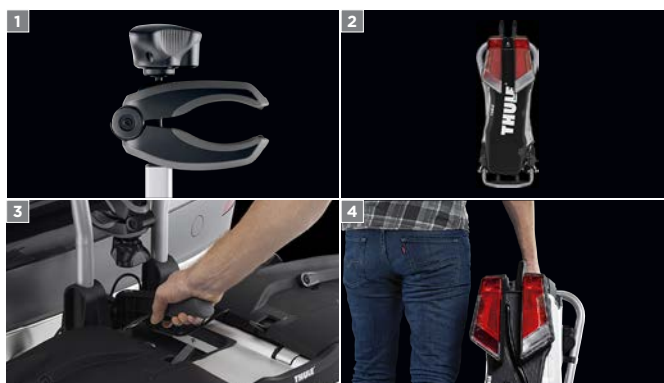



Thule EuroClassic G6

An optimal solution for the family who need a premium bike carrier with flexibility and great loading capacity. The Thule EuroClassic G6 is available in two versions – for two bikes or three bikes, both with the possibility to add an additional bike with an adapter. A premium, versatile carrier that fits all bike sizes.

FEATURES

- 1** UPDATE: New improved, detachable frame holders with Thule AcuTight torque limiter knobs that “click” when optimal torque is reached (for 22-80 mm round and oval frames). ■ Loading capacity is 25 kg for each bike, enabling transport of lighter E-bikes.
- 2** Foot pedal tilt. ■ Wide tilt angle allows opening of very large rear-doors (e.g. VW T5) – even with four bikes mounted.
- 3** Adjustable one hand coupling with low closing force for easy mounting of carrier.
- 4** Pump buckles with long wheel straps for easy fastening of wheels.
- 5** Carrier lockable on tow bar and all bikes lockable to carrier.

FOR ACCESSORIES, SEE PAGE 58-59.

FOR SPECIFICATIONS, SEE PAGE 60.



bike 06/12
 TEST FAHRRADTRÄGER URTEIL: SEHR GUT
 Thule EuroClassic G6 LED 929



Add to your your Thule EuroClassic G6



Thule EuroClassic G6 bike adapter 9281
 Increase the capacity with one bike. Fits all bikes and wheel sizes.





Thule EuroWay G2

The perfect choice if you want the best compact and lightweight bike carrier. The award-winning Thule EuroWay G2* has a modern design and weighs only 13 kg as a result of using aluminium and other high-tensile lightweight materials. Available in two versions: Thule EuroWay G2 921 for two bikes and Thule EuroWay G2 923 for three bikes.

FEATURES

1 UPDATE: New improved, detachable bike arms for convenient mounting of bikes (for 22-80 mm round and oval frames). **2** Smart foot pedal tilt. **3** Easy trunk access even with bikes mounted. **4** Adjustable one hand coupling with low closing force for easy mounting of carrier. **5** Pump buckles with long wheel straps for easy fastening of wheels. **6** Folds flat easily for simple storage and fits in most trunks. **7** Carrier lockable on tow bar and all bikes lockable to carrier.

FOR ACCESSORIES, SEE PAGE 58-59.

FOR SPECIFICATIONS, SEE PAGE 60.



* Eurobike Award winner in 2010 and winner of the renowned German consumer test institute StiWa's and the German automobile club ADAC's test of tow bar mounted bike carriers in 2011.



Add to your your Thule EuroWay G2



Thule AcuTight Knob 528
Torque limiter knob that "clicks" when optimal hold is reached.





Thule EuroRide

The Thule EuroRide is a functional bike carrier fulfilling all your basic needs. It has the same features as the other carriers, but in a simpler execution. Available in two versions: Thule EuroRide 941 for two bikes and Thule EuroRide 943 for three bikes.

FEATURES

1 Hand operated tilt for boot access even with bikes mounted. ■ Quick-mounting handle attaches carrier to tow ball with only a few turns. ■ Movable wheel holders with soft straps. ■ Stable frame holders for bike frames (up to 70 mm). ■ Carrier lockable on tow bar and bike positions lockable with accessory Thule Lockable Knob 526 or Thule AcuTight Knob 528.

FOR ACCESSORIES, SEE PAGE 58-59.
FOR SPECIFICATIONS, SEE PAGE 60.



Add to your your Thule EuroRide



Thule AcuTight Knob 528
Torque limiter knob that "clicks" when optimal hold is reached.





Thule EuroPower

Electric, downhill or heavy bikes have special needs when it comes to transport. The Thule EuroPower meets all these needs as a very robust and stable carrier with high loading capacity. The distance between the wheel trays is extra-large for more clearance between the bikes. This carrier fits all types of bikes and wheel sizes.

FEATURES

1 UPDATE: New improved, detachable bike arms for convenient mounting of bikes (for 22-80 mm round and oval frames). **2** Loads 2 x 30 kg enabling transport of E-bikes/ Pedelecs. **3** Extra-large distance between wheel holders for more clearance between the bikes. **2** Smart foot pedal tilt for easy boot access even with bikes mounted. **3** Adjustable one hand coupling with low closing force for easy mounting of carrier. **4** Pump buckles with long wheel straps for easy fastening of wheels. **4** Carrier lockable on tow bar and all bikes lockable to carrier.

FOR ACCESSORIES, SEE PAGE 58-59.

FOR SPECIFICATIONS, SEE PAGE 61.



Add to your your Thule EuroPower



Thule AcuTight Knob 528

Torque limiter knob that "clicks" when optimal hold is reached.

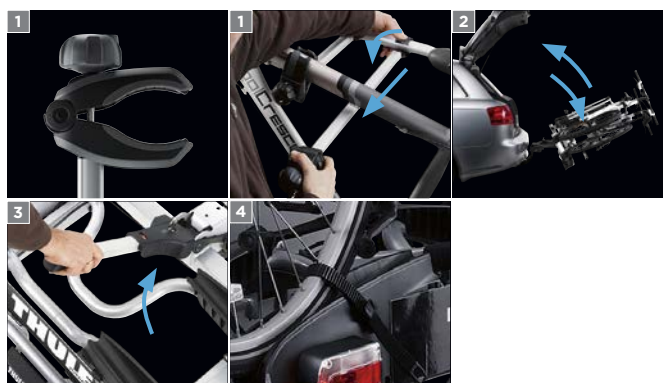

Thule RideOn

Our basic, tiltable bike carrier.

FEATURES

■ Hand operated tilt for boot access even with bikes mounted. ■ Smart coupling, fits most tow bars. ■ Bikes fixed in place with soft straps.

FOR ACCESSORIES, SEE PAGE 58-59.

FOR SPECIFICATIONS, SEE PAGE 61.



Thule HangOn

A basic and easy to use carrier if you need to transport 3-4 bikes. Available in two sizes - the 972 and 974 carry three bikes while the 9708 carries four bikes.

FEATURES

■ Strong coupling that needs no pre-adjustment for fixing. ■ Soft, protective frame holders keep the bikes in place. ■ Bikes are at convenient height from the ground. ■ Pre-assembled with strap and reflectors included for extra safety. ■ Folds flat for easy storage. ■ 972/9708 tiltable for access to the trunk. ■ 972/974 prepared for fitting light board 976 with adapter 9761 (not 9708).

FOR ACCESSORIES, SEE PAGE 58-59.

FOR SPECIFICATIONS, SEE PAGE 61.



Thule Xpress 970

A basic, quick and easy to use 2-bike carrier. Stow it in your trunk for short trips or transporting bikes to and from school.

FEATURES

■ Soft, protective frame holders keep the bikes in place. ■ Bikes are at convenient height from the ground. ■ Pre-assembled with strap and reflectors included for extra safety. ■ Folds flat for easy storage. ■ Prepared for fitting light board 976 with adapter 9761.

FOR ACCESSORIES, SEE PAGE 58-59.

FOR SPECIFICATIONS, SEE PAGE 61.



> Bike travel cases



Thule Round Trip Transition

This hard shell premium bike case with integrated bike assembly stand makes travelling with your bike simple.

FEATURES

- The combination of the durable ABS construction and the aluminium Click-Rail delivers maximum bike protection during transport.
- Nylon wheel bags prevent frame and wheel contact.
- Thule Thru-Axle Adapters for 15 mm and 20 mm axles included.
- Integrated bike assembly stand, doubles as a convenient bike holder and assembly stand making it easy to assemble and disassemble your bike.
- Integrated wheels and handles for easy transport and manoeuvrability.
- Easy to pack and assemble making travelling easy.
- For most road, mountain and cyclocross bikes with a wheelbase of up to 121.9 cm.

Internal dimensions: 134 x 37.5 x 90.2 cm.
 External dimensions: 137.2 x 39.4 x 94 cm.
 Weight: 15.4 kg.



Thule Round Trip Pro

Soft shell bike cases with integrated bike assembly stand makes travelling with your bike simple.

FEATURES

- Rugged nylon shell expands around aluminium Click-Rail to protect the bike during transport.
- Durable and removable side panels protect the bike.
- Nylon wheel bags prevent frame and wheel contact.
- Thule Thru-Axle Adapters for 15 mm and 20 mm axles included.
- Integrated bike assembly stand, doubles as a convenient bike holder and assembly stand making it easy to assemble and disassemble your bike.
- Integrated wheels and handles for easy transport and manoeuvrability.
- Lightweight and easy to store with folding side panels and collapsible frame.
- For most road, mountain and cyclocross bikes with a wheelbase of up to 116.8 cm.

Internal dimensions: 124.5 x 27.9 x 84.5 cm
 External dimensions: 125.7 x 29.8 x 88.9 cm
 Weight: 9.5 kg



Integrated bike assembly stand included with both Round Trip Transition and Round Trip Pro.



2014





Add to your bike carrier



Thule EuroClassic G5/G6 bike adapter 9281

Increase the capacity of your Thule EuroClassic G5/G6 carrier with one bike using the Thule Bike Adapter 928-1. Fits all bikes and wheel sizes.



Thule EasyFold carrying bag 931-1

Protecting you and your car from dirt when transporting and storing the Thule EasyFold.



Thule loading ramp 9152

Convenient removable ramp for easy loading and unloading of your bikes. Fits Thule EasyFold, EuroPower, EuroClassic G6, and EuroWay G2.



Thule bike frame adapter 981

Telescopic adapter for easiest possible fitting of bikes with non-standard frames, ladies' bikes, BMXs, downhill bikes, etc. Mounts between saddle-post and steering. For bike carriers with bikes hanging.



Thule off-road adapter 9042 and 9202

Adapter 9042 for fitting the Thule EuroClassic G6 (and Thule EuroClassic G5) to cars with exterior spare wheel. Adapter 9202 for Thule EuroWay G2.



Thule bike frame adapter 982

Frame adapter for easiest possible fitting of bikes with non-standard frames, ladies' bikes, downhill bikes, etc. Also suitable for sensitive carbon frames that need extra protection. For bike carriers with bikes standing on a platform.



Thule wheel adapter 9772

Special protection for road bikes and mountain bikes. Place between the strap and the rim. Protects the rim on mountain bikes and helps secure the wheels of road bikes.



Thule number plate 9762

A blank plate for fitting to the number plate holder of the bike carrier in countries where it's not allowed to remove the real plates from the car. Write on it by hand or use stickers.



Thule light board 976

Substitutes the most important rear lights on your car. Easily fitted with light board adapter 9761 (Thule HangOn 972/974, and Thule Xpress 970), or by using straps (Thule HangOn 9708).

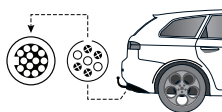

Thule adapter 9906

If the car is equipped with a 7-pin electrical outlet this adapter converts it, making it possible to fit Thule's 13-pin products.

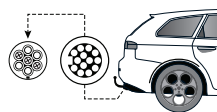

Thule adapter 9907

If the car is equipped with a 13-pin electrical outlet this adapter converts it, making it possible to fit Thule's 7-pin products.



Thule wheel bag 563 XL
Great accessory for Thule Sprint and Thule OutRide.



Thule SlideBar 891-893
The Thule SlideBar makes loading of bikes on your car roof extremely easy, as the bar slides out on either side of the car. Please see page 14.



Thule 15 mm through-axle adapter 561-1
For Thule OutRide 561 - for bikes with 15 mm through-axes.



Thule wheel carrier 545-2
A carrier for the front wheel with regular axle. Also suits wheels with disc brakes. Possible to fold down when not in use. Fits Thule WingBar Edge, WingBar, SlideBar, AeroBar, and Thule SquareBar. A great accessory for Thule Sprint and Thule OutRide.



Thule cable lock 538
Plastic coated, 180 cm long steel cable that locks almost anything. With lock protection.



Thule AcuTight Knob 528
Accessory for rear mounted bike carriers. Adds torque limiter function for clear sign-off of correct mounting of bikes.



Thule lock 957
For locking Thule HangOn and RideOn to the tow bar.



Thule knob lockable 526/527
Accessory for rear mounted bike carriers. Locks the frame holder. Art. no. 526 = 2 pack. Art. no. 527 = 4 pack.

Thule One-Key System
Avoid the hassle with many different keys, upgrade to Thule One-Key System and get one key for all Thule products. Available in sets of 4, 6, 8 and 12 locks. Check www.thule.com for more information.



Thule Bike Stackers 5781
Freestanding rack for holding up to 2 bikes. Bike hanger arms adjustable in height and with V-shaped bike holders.



Thule wall hanger 9771
For functional storage of bikes and bike carriers. Load capacity 40 kg.

Bike carriers for roof mounting



Name	Thule Sprint 569	Thule ProRide 591	Thule OutRide 561	Thule FreeRide 532
Max. number of bikes	1	1	1	1
Load capacity (kg)	17	20	17	17
Mounting of bike	Front fork/back wheel	Frame/wheel	Front fork/back wheel	Frame/wheel
Fits frame dimensions (mm)	All	Ø Up to 100*	All	Ø 22-70*
Fits wheel dimensions	All	All	All	All
Self-adjusting frame holder		•		
Adjustable quick-straps for wheels	•	•	•	•
Locks bike to carrier	•	•	•	•
Locks carrier to load carrier	•	•	•	•
Can be mounted on right or left side	•	•	•	•
Fits Wing, Slide & AeroBar	•	•	•	•
Fits SquareBar		•	•	•
Adapter for T-track (20x20mm) ¹	Included	Included	Included	Included
Adapter for T-track (30x23mm) ²	889-4	889-1	889-3	889-3
TÜV approved	•	•	•	•
Fulfills City Crash norms	•	•	•	•
Miscellaneous	Aluminium. Also for bikes with disc brakes. Does not fit bikes with thru axles. Only fits load carriers with t-tracks.	Aluminium. Very easy to mount. *Round frame 22-80 mm, oval frame 80x100 mm.	Aluminium. Also for bikes with disc brakes. Adapter for forks with 20 mm axles is included.	*Oval frame, max 65x80 mm.

¹ Fits WingBar Edge, WingBar, SlideBar & AeroBar.

² Fits e.g. some BMW and Renault original roof racks.

Bike carriers for tow bar mounting



Name	Thule EasyFold		Thule EuroClassic G6		Thule EuroWay G2		Thule EuroRide	
	932	928	929	921	923	941	943	
Max. number of bikes	2	2 (3 with adapter 928-1)	3 (4 with adapter 928-1)	2	3	2	3	
Load capacity (kg)	60	51	60	46	51	36	45	
Max bike weight (kg)	30	25	25	24	24	20	20	
Wheel distance (cm)	22	20	20	19	19	17	17	
Size (cm)	123 x 61 (31 x 61 x 68 when folded)	137 x 48	137 x 65	102 x 55	102 x 73	105 x 58	105 x 75	
Weight (kg)	16.9	17.6	20.7	13.3	16.4	14.1	17.9	
Fits frame dimensions (mm)	22-80	22-80	22-80	22-80	22-80	20-70		
Wheel mounting on adjustable holders	Pump buckles	Pump buckles	Pump buckles	Pump buckles	Pump buckles	Adjustable straps	Adjustable straps	
Detachable frame holders	•	•	•	•	•			
Locks bike to carrier	•	•	•	•	•	Accessory 526/527/528		
Locks carrier to car	•	•	•	•	•	•	•	
Tilt function, with bikes	Foot pedal	Foot pedal	Foot pedal	Foot pedal	Foot pedal	Hand operated		
Usable with loading ramp 9152	•	•	•	•	•			
Fits cars with exterior spare tyre		With spare wheel adapter 9042		With spare wheel adapter 9202				
Rear lights	•	•	•	•	•	•	•	
Powerplug	7-pin (13-pin with adapter 9907)	13-pin (7-pin with adapter 9906)		7-pin (13-pin with adapter 9907)		7-pin (13-pin with adapter 9907)		
TÜV/EuroBe approved		•	•					
Fulfills City Crash norms	•	•	•	•	•	•	•	
Miscellaneous		Max bike weight for adapter 928-1 is 15 kg.						

Name	Thule RaceWay		Thule BackPac	Thule ClipOn High		Thule ClipOn		Thule FreeWay
	991	992	973	9105	9106	9103	9104	968
Max. number of bikes	2	3	2 (3 with adapter 973-23, 4 with 973-23 + 973-24)	2	2	3	3	3
Load capacity (kg)	30	45	60	30	30	45	45	45
Weight (kg)	9.8	10.6	14	10	12.9	6.1	7.1	5.1
Mounting of carrier	Steel ratcheting cables		With BackPac kit	Snap-on mounting system		Snap-on mounting system		Adjustable straps
Fits frame dimensions (mm)	All		22-80	22-80		All		All
Fits wheel dimensions	All		All	All		All		All
Rubber coated frame holder	•	•	•	•	•	•	•	•
Detachable frame holders			•	•	•			
Wheel mounting on adjustable holders			Quick release straps	Quick release straps				
Locks bike to carrier	•	•	•	•	•	Accessory 538		Accessory 538
Locks carrier to car	•	•	Accessory 567					
Boot access with carrier mounted	•	•	•	•	•	•	•	•
TÜV approved			•	•	•			
Miscellaneous	Preassembled. Sturdy strap for fixation of bikes included.		Placement that does not cover the rear lights or number plate.	Placement that does not cover the rear lights or number plate. 3rd Brake light 9902 available.		Easily mounted with tightening flexibility. Sturdy strap for fixation of bikes included.		Sturdy strap for fixation of bikes included. Also fits sedans.

See the Thule Fit Guide or www.thule.com for details regarding fit to different car models.



Thule EuroPower	Thule RideOn		Thule HangOn			Thule Xpress
916	9502	9503	972	9708	974	970
2	2	3	3	4	3	2
60	30	45	45	60	45	30
30	17	17	15	15	15	15
25	15	15				
118 x 63	105 x 55	105 x 75	47 x 54	47 x 64	47 x 54	43 x 34
18.9	9.5	12	7.2	10.3	7.2	4.3
22-80	All	All	All	All	All	All
Pump buckles	Adjustable straps	Adjustable straps				
•						
•	Accessory 538		Accessory 538			Accessory 538
•	Accessory 957		Accessory 957			With padlock
Foot pedal	Hand operated		Hand operated			
•						
With spare wheel adapter 9042						
•	•	•	Accessory 976			Accessory 976
7-pin (13-pin with adapter 9907)	7-pin (13-pin with adapter 9907)					
•	•	•	•	•	•	•
Fits wheels with up to 2.2" width			Adapter 9761 needed for fitting lightboard 976 on 972 and 974.			Straps for fixation of bikes included.

> Water





SEIZING MOMENT BY ANDY IRONS
1978 - 2016

HISTORIC SEA
SURF SHOP



6

SURF LESSON
SURF SALES
TOUR
Basic
Intermediate
Advanced
No Experience
Needed
Private
Group
Sea



› To the water and beyond.

We humans have thought up numerous ways to master water, and kayaks, canoes, surfboards, and wakeboards might be the most exciting. At Thule we've made it our mission to get your gear to the water, by developing ultra-safe racks that are easy to mount, space-saving and equipped with powerful straps and protective pads. We'll get you to the water safe and sound. Then it's your choice if you want to go with the flow or against the tide.



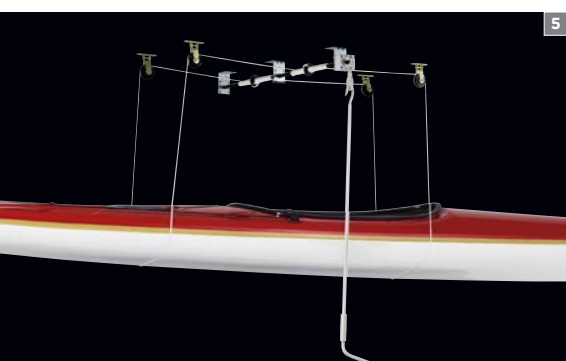

FEATURES

- 1** Tiltable in a wide angle for easiest possible loading and unloading of your kayak.
- 2** Exclusive telescopic design, with integrated strap.
- 3** Hook the Thule Quick Draw to your car and boat, give it a yank, and get going. Sold in sets of two. Perfect for use as a bow and stern line.
- 4** The innovative lockable strap prevents theft of your kayak or other equipment you strap on to your roof rack.
- 5** With the Thule boxlift 571, you can easily lift up your roofbox to the garage ceiling. The lift works just as perfectly for kayaks and surfboards.
- 6** Thule multi-purpose carrier 855 carries up to three oars, paddles, etc.



Thule K-Guard 840

Maximum safety and security mark the new Thule K-Guard – probably the ultimate solution for kayak transportation. Spend less time loading and unloading and more time in your kayak.

FOR SPECIFICATIONS, SEE PAGES 68.

FEATURES

- 1 The rubber supports are designed for adapting to differently shaped kayaks, maintaining good pressure distribution onto the kayak hull.
 - 2 The first-ever kayak carrier to be lockable both kayak to carrier (with lockable steel-core strap), and carrier to roof rack.
 - 3 Tilttable in a wide angle for easiest possible loading and unloading of the kayak.
- Use the T-track of the Thule SlideBar, WingBar, or ProBar, or make it grip around the SquareBar.
 - Very quick and easy to fit to the roof rack.
 - Elegant aluminium cradles.
 - City Crash tested and approved for kayaks up to 45 kg.



reddot design award
winner 2012



Add to your Thule K-Guard



Thule SlideBar 891-893

The Thule Slidebar makes loading of bikes, kayaks or canoes extremely easy, as the bar slides out on either long side of the car body. Please see page 14.

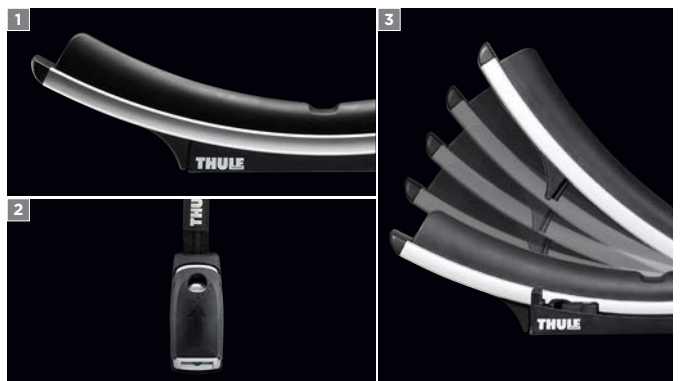



Thule Hull-a-Port Pro 837

This premium vertical carrier combines maximum strength and protection with greater versatility by folding down when not in use.

FEATURES

- Folds down to the level of the load carrier, so there is no need to take it off to get into the garage.
- Stable, space-saving design.
- Pads with thick felt layer to protect the hull.
- Powerful straps keep the kayak firmly secured.
- A rubber pad around the strap buckle protects the kayak and the car from scratches during loading and transport.
- Approved to carry kayakers up to 45 kg.

FOR SPECIFICATIONS, SEE PAGE 68.



Thule Hull-a-Port 835-1

This standard J-style cradle delivers superior carrying performance and protection with its 4-touchpoint adjustable padding and steel design.

FEATURES

- Wide mouth J-profile offers easier loading and unloading.
- Stable, space-saving design.
- Pads with thick felt layer to protect the hull.
- Powerful straps keep the kayak firmly secured.
- A rubber pad around the strap buckle protects the kayak and the car from scratches during loading and transport.
- Approved to carry kayakers up to 45 kg.

FOR SPECIFICATIONS, SEE PAGE 68.



Thule kayak carrier 874

Adapts perfectly to the shape of the kayak.

FEATURES

- Four adjustable rubber supports keep the kayak stable during transport.
- Powerful straps keep the kayak firmly secured.
- A rubber pad around the strap buckle protects the kayak and the car from scratches during loading and transport.
- Easy to mount on Thule SquareBars and bars with T-track (T-track adapter included).

FOR SPECIFICATIONS, SEE PAGE 68.



Thule Hydroglide 873

Easily loaded by one person.

FEATURES

- Felt-lined rear supports for easy loading. Simply slide the kayak up onto the car roof.
- Powerful straps and adjustable rubber support on the front holder keep the kayak firmly secured.
- A rubber pad around the strap buckle protects the kayak and the car from scratches during loading and transport.
- Easy to mount on Thule SquareBars and bars with T-track (T-track adapter included).

FOR SPECIFICATIONS, SEE PAGE 68.



Thule 520-1 kayak support

Carries 1-2 kayakers and also fits small boats or surfboards.

FEATURES

- Strap length 2 x 275 cm, included.
- Polypropylene buckle protection.
- Easy to mount on Thule SquareBars and bars with T-track (T-track adapter included).

FOR SPECIFICATIONS, SEE PAGE 68.



Thule canoe carrier 579

Carrier made for canoes and other small boats.

FEATURES

- Soft support pads for protection.
- Secured with straps. ■ Carries one canoe or small boat.



New

Thule Portage 819

Thule's easiest-loading canoe carrier with universal roof rack compatibility.

FEATURES

- Durable gunwales with cushioned base pads secure canoe for transport. ■ Gunwales with ramped sides for easy loading. Soft, weather resistant base padding protects canoe during transit. ■ Includes all centre straps with buckle bumpers to transport one canoe. ■ Fits all Thule Rack Systems.* ■ T-Track compatible.

* T-track adapter required when using Thule SlideBar.



Thule SUP Taxi 810

Premium looking Stand-Up Paddleboard (SUP) carrier with universal and safe mounting design.

FEATURES

- Exclusive, telescopic design delivers a custom fit for board widths from 700–860 mm. ■ Heavy-duty, steel reinforced webbing and spring loaded locking cam provide unsurpassed security for your boards. ■ Integrated fixation strap for easy and convenient loading. ■ Soft, weather resistant padding protects boards during transit. ■ 4 One-Key locks (included). 2 for locking strap assembly and 2 for Speed-Link. ■ Equipped with Speed-Link mounting system for convenient, tool-free mounting to the roof rack. ■ Two board capacity.

Water sport carries



Name	Thule K-Guard 840	Thule Hull-a-Port Pro 837	Thule Hull-a-Port 835-1	Thule kayak carrier 874	Thule Hydroglide 873	Thule kayak support 520-1
Load	Kayak	Kayak	Kayak	Kayak	Kayak	Kayak
Load capacity	45 kg	1 kayak	1 kayak	1 kayak	1 kayak	2 kayaks
Length of strap (cm)	2 x 400	2 x 275	2 x 275	2 x 400	2 x 400	2 x 275
Rubber protection for buckle	•	•	•	•	•	
Fits all mast dimensions						
Fits other crafts	Surfboard or small boat			Surfboard or small boat	Surfboard or small boat	Surfboard or small boat
Lock	•	Accessory 841 or 538	Accessory 841 or 538	Accessory 841 or 538	Accessory 841 or 538	Accessory 841
Fits Wing, Slide, AeroBar & ProBar	•	• ¹	• ¹	•	•	•
Fits SquareBar	•	•	•	•	•	•
TÜV approved	•	•	•	•	•	

¹ Fits around the bars and in T-track slot for Thule SlideBar with adapter 886.

² Fits around the bars, not compatible with SlideBar.



New

Thule SUP Shuttle 811

Telescoping-width SUP and surfboard carrier with built-in board protection and universal roof-rack compatibility.

FEATURES

- Exclusive telescopic design delivers a custom fit for board widths up to 34" wide.
- Dual loading design allows for transport of two boards with maximum stability.
- Soft, weather resistant base padding protects boards during transit.
- Fits all Thule Rack Systems.*
- Adjustable wrap-around padding on straps to protect board from strap abrasion.
- T-Track compatible.

* T-track adapter required when using Thule Slidebar.



Thule wave surf carrier 832

Specially designed for surfboards.

FEATURES

- The board sits in a soft, protective rubber cradle.
- Secured with straps.
- Carries up to two boards.



Thule sailboard carrier 533/833

Designed to carry one board and two masts.

FEATURES

- Secured with straps.
- 533 for use with Thule SquareBar, 833 for use with Thule WingBar, Thule SlideBar, Thule AeroBar and and Thule ProBar.
- Protective pads included.

Add to your Water sport carrier



Waterslide 839

Protect your vehicle during the loading and unloading of your boat. Non-skid underside and two bar straps hold mat in place while loading and unloading. Smooth top surface protects the boat and vehicle in case of contact.



Thule Eye Bolt 320

If you're going to mount your carrier on a Thule SlideBar, you might need a Thule Eye Bolt in order to use the slide function. The Thule Eye Bolt is mounted into the T-track and you fasten your straps to it.



Thule Lockable Strap 841

The innovative lockable strap prevents theft of your kayak or other equipment you strap on to your roof rack.



Thule Quick Draw 838

Perfect for use as a bow and stern line. Hook the Thule Quick Draw to your car and boat, give it a yank, and get going. Sold in sets of two.



New



New



Thule canoe carrier 579	Thule Portage 819	Thule Sup Taxi 810	Thule SUP Shuttle 811	Thule wave surf carrier 832	Thule sailboard carrier	
					533	833
Canoe	Canoe	Stand up paddle board	Stand up paddle board	Wave surf board	Sailboard and mast	
1 canoe	1 canoe	2 SUP boards	2 SUP boards	1-2 surfboards	1 sailboard + 2 masts	
2 x 400				2 x 180	2 x 275	2 x 275
•	•		•	•	•	•
Small boat	Small boat		Fits all surfboards		Surfboards	
Accessory 841 or 538		•		Accessory 841 or 538	Accessory 841 or 538	
	•	• ²	•	•		•
•	•	•	•	•	•	
•				•	•	•

> Winter







› Snow adventures in safe style.

Skiing is in a class of its own among outdoor activities. We try to match that by making ski carriers that really stand out among the competition. All Thule ski carriers are easy to mount, load and unload, whatever the weather. In addition they are elevated to prevent roof damage, and extendable for making those last minute additions. In our winter range you'll also find our snow chains. Getting to the white open spaces is no trouble - even if it's all downhill from there.





FEATURES

- 1** Easy-fit is the award-winning family of snow chains developed for passenger cars and SUVs. Combines the most innovative technology with cutting edge design.
- 2** With a simple hand action, the ski carrier conveniently slides out so that you can load and unload your skis without having to stretch over the car roof.
- 3** The K-Summit family contains the most exclusive external snow chains, all of which are exceptionally user-friendly. Equipped with one-hand ratchet system allowing effortless fitting.
- 4** Extra large push buttons make it easy to open the ski carrier, even with gloves on.
- 5** Lock your skis to the ski carrier - and your ski carrier to the load carrier.

› Winter sports carriers





New

Thule SkiClick

A carrier developed for cross-country skis. Just click your skis in place, fit the innovative ski strap and drive away.

FOR SPECIFICATIONS, SEE PAGES 79.

FEATURES

- Part of the Thule system that fits to roof racks and walls for storage with a simple click. Slim protection bag to stop dirt and dust sticking to your ski wax (accessory 7294).
- Fix skis easily to the car using the Thule SkiClick.
- Smart design saves space on your car.
- Minimum wind drag gives less environmental effect.
- Safety lock.
- Thin material packs up tight when not used.
- Thule SkiClick and Thule SkiClick Bag are perfect for transporting skis daily.



Thule Xtender 739

With a simple hand action the ski carrier conveniently slides out so that you can load and unload your skis without having to stretch over the car roof.

FEATURES

- The carrier slides out for ease of loading and unloading.
- Extendable for easy loading and unloading, without having to stretch over the car roof and risk getting your clothes dirty or scratching the car.
- Exclusive aerodynamic design in aluminium.
- Raised design to keep high bindings from damaging the car roof.
- Extra large push buttons make it easy to open the ski carrier.
- Holds up to six pairs of skis or four snowboards.

FOR SPECIFICATIONS, SEE PAGE 79.



Thule Deluxe 726/727/740

Exclusive, aerodynamic design in aluminium.

FEATURES

- Height adjustable to keep high bindings from damaging the car roof.
- Extra large push buttons make it easy to open the ski carrier.
- Available in three sizes up to six pairs of skis or up to four snowboards.

FOR SPECIFICATIONS, SEE PAGE 79.



Thule Snowpro 745/746/ Snowpro Uplifted 748

Tried and tested by thousands of skiers around the world.

FEATURES 745/746

- Available in three sizes for three to four pairs of skis or two snowboards.

FEATURES UPLIFTED 748

- Holds up to four pairs of skis or two snowboards.
- The carrier can be raised 30 mm for transporting skis with high bindings.

FOR SPECIFICATIONS, SEE PAGE 79.

> Snow chains





Thule Easy-fit family

In 12 seconds the innovative Thule Easy-fit will be mounted on the wheel, making it the fastest to fit snow chain ever and a Guinness World Record holder. Now also available in new version for SUV (Thule Easy-fit SUV) and in high performance version for passenger cars (Thule Easy-fit CU-10).

FEATURES

1 The central aluminium bar is the core of the tightening system: open the integrated pedal and push with the foot to activate the automatic tensioning. The chain will be tightened automatically at first car motion. **2** The internal rigid arch system allows a very intuitive fitting from the upper part of the wheel. **3** Welded S-shaped steel plates connecting the aluminum bar with the internal rigid arch system. **4** Automatic release - pull the safety device, push the red buttons on the aluminum bar and the chain is released. ■ The fitting is very intuitive and is done from the top to the bottom of the wheel. ■ Practical and resistant bag with high visibility instructions, usable as kneel-mat during fitting and removing.



FOR SPECIFICATIONS, SEE PAGE 79.

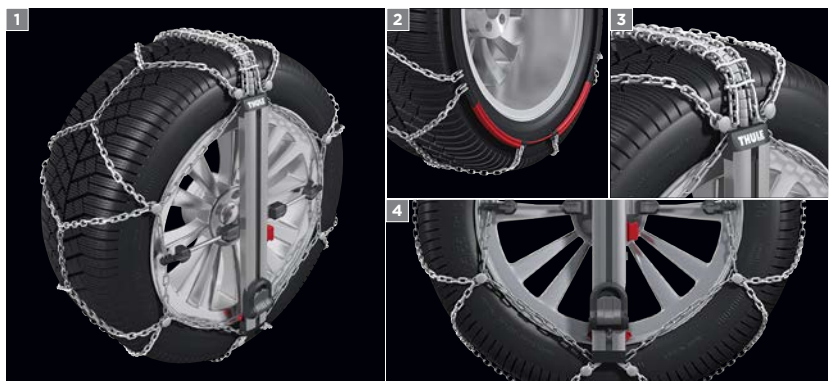



Thule K-Summit

The smartest external chain for passenger cars.

FEATURES

- 0 mm clearance behind the wheel.
- Fitted on the original nut/bolt of the wheel.
- Innovative ratched system which permits effortless fitting.
- Tensioning springs decrease dynamic elevation and enable perfect fitting on several tyre sizes.
- Tread chain with alternation of special injection-moulded plastic plates with hard metal studs and special alloyed steel chain.
- No contact with alloy rims.
- Foldable arms for easy storage in a smart bag.
- Innovative design.
- Also available: Thule K-Summit XL and Thule K-Summit XXL for small and big SUVs.

FOR SPECIFICATIONS, SEE NEXT PAGE.

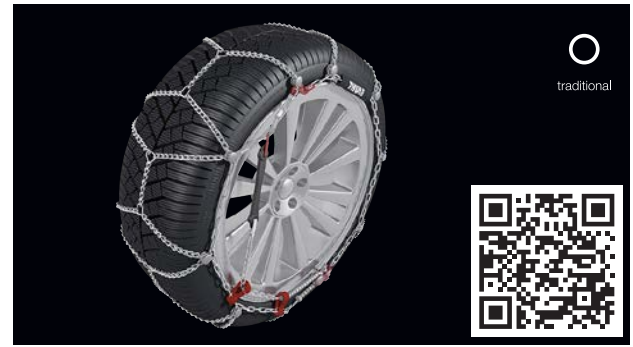

Thule CK-7

The thinnest snow chain in the world.

FEATURES

- 7 mm inside and on-the-tread clearance.
- Bottom to top fitting thanks to the internal flexible cable.
- Special twisted links, chain thickness reduced to 7 mm.
- Superior driving comfort.
- Micro-regulation system for perfect tensioning.
- Closed shortening hooks avoid coils on the chain.
- Alloy wheels protectors (optional application).
- Colour-coded assembling points.

FOR SPECIFICATIONS, SEE NEXT PAGE.



Thule CS-10

The smart snow chain with automatic release.

FEATURES

- 10 mm inside clearance.
- External quick release system: remove the snow chain by pulling the special device.
- Self-tensioning system: just one stop to fit the chain.
- Micro-regulation system for a perfect tensioning.
- Alloy wheels protectors (optional application).
- Also available for SUVs and RVs.

FOR SPECIFICATIONS, SEE NEXT PAGE.



Thule CL-10

Ice-breaker reinforcements and automatic tensioning.

FEATURES

- 10 mm inside clearance.
- Self-tensioning system: just one stop to fit the chain.
- Asymmetrical diamond pattern chain with ice-breaker reinforcements.
- Micro-regulation system for a perfect tensioning.
- Alloy wheels protectors (optional application).
- Also available for SUVs and VANs.

FOR SPECIFICATIONS, SEE NEXT PAGE.



Thule CB-12

Simplicity and sturdiness.

FEATURES

- 12 mm inside and on-the-tread clearance.
- Manual tensioning system: one stop to fit the chain and one to tighten it.
- Closed shortening hooks avoid coils on the chain.
- Also available for SUVs, RVs and VANs.

FOR SPECIFICATIONS, SEE NEXT PAGE.



Winter sport carriers



Name	Thule SkiClick	Thule Xtender	Thule Deluxe			Thule Snowpro		Thule Snowpro Uplifted
	7291	739	740	726	727	745	746	748
Loading width (cm)		60	30	40	60	30	40	40
Max pairs of skis or snowboards	1*/0	6/4	3/2	4/2	6/4	3/2	4/2	4/2
Extra large push-button		•	•	•	•			
Wide rubber protectors		•	•	•	•	•	•	•
Room for high bindings		•	•	•	•			•
Locks skis to carrier	Safety lock	•	•	•	•	•	•	•
Locks carrier to load carrier		•	•	•	•	•	•	•
Fits Wing, Slide & AeroBar	•	•	•	•	•	With adapter 888	With adapter 888	With adapter 887
Fits SquareBar	•	•	•	•	•	•	•	•
TÜV approved		•	•	•	•	•	•	•
Miscellaneous	Smart ski carrier for convenient transport and storage of cross country skis. Thule SkiClick Bag 7294 available as accessories.	Aluminium. Extendable for easier loading and unloading.	Aluminium. 25 mm raise adapter included. Cannot be raised when mounted on aero bars.					Raised 30 mm, making room for higher bindings.

* Only for cross country ski.
 739: Not suitable with WingBar Edge: 9581, 9584.
 727: Not suitable with WingBar Edge: 9581, 9582, 9584, 9591, 9594.

Snow chains



Name	Thule Easy-fit family	Thule K-Summit family	Thule CK-7	Thule CS, XS models	Thule CL, CG, XG models	Thule CB, CD, XB, XD models
Intuitive fitting	•					
External Fitting		•				
Conventional fitting			•	•	•	•
External release	•	•		•		
Self-tensioning system (one stop for fitting)	•			•	•	
Manual tensioning (2 stops for fitting)			•			•
Alloy wheel protection	•	•	•	•	•	Only for CD and XD models
ABS-ESP compatible	•	•	•	•	•	•



Awards for Thule CS-10.

Awards for Thule CL-10.

› The world of Thule.

We are pretty sure that you are eager to load your gear and get out there. Before, or when you come back, take another look at the world of Thule. Our wide range of products, such as racks, snow chains, bags, cargo and towing solutions, as well as carriers for bikes, winter and water sports and for professional use are available at our website. You will also find all the necessary information about our trailers for boats and horses.

THULE FITGUIDE

When you have found the right loading solution, you also need to adapt it to your vehicle. One of the main functions on thule.com is the Fit Guide. Step by step, it will help you to find out which products fit your type of car.



www.thule.com

Get to know our products, use the handy Fit Guide and find our dealers. The Fit Guide is available on our mobile site, www.m.thule.com.





» PART OF THULE GROUP

THULE PARTNER PROGRAMME

Thule has a large number of dealers all over the world and some selected stores are part of the Thule Partner Programme. These stores offer our complete range of products and the personnel are specially educated in all of our solutions. Use our Dealer Locator to find the suitable dealer for your needs in your area.

THULE IN SOCIAL MEDIA

The full experience of Thule is completed through our other media channels. Visit us at Facebook or be inspired at our YouTube channel, which among other things contains a number of product films.

www.facebook.com/thulebringyourlife
www.youtube.com/thulebringyourlife

THULE GROUP

Thule is a part of Thule Group, a collection of international brands that have one common mission: developing smart ways to simplify your active life.

www.thulegroup.com



Thule Sweden AB

Box 69, SE-330 33 Hillerstorp, Sweden.

Tel +46 370-255 00, Fax +46 370-229 08.

www.thule.com

5211400020 English. Local variations in product range may occur and products may be subject to change without further notice. With reservation against possible mistakes in the contents of the catalogue.
Production: NY. Photo: Marcel Palosi, Micke Strimmed.
Copyright 2014 Thule Sweden AB.

